

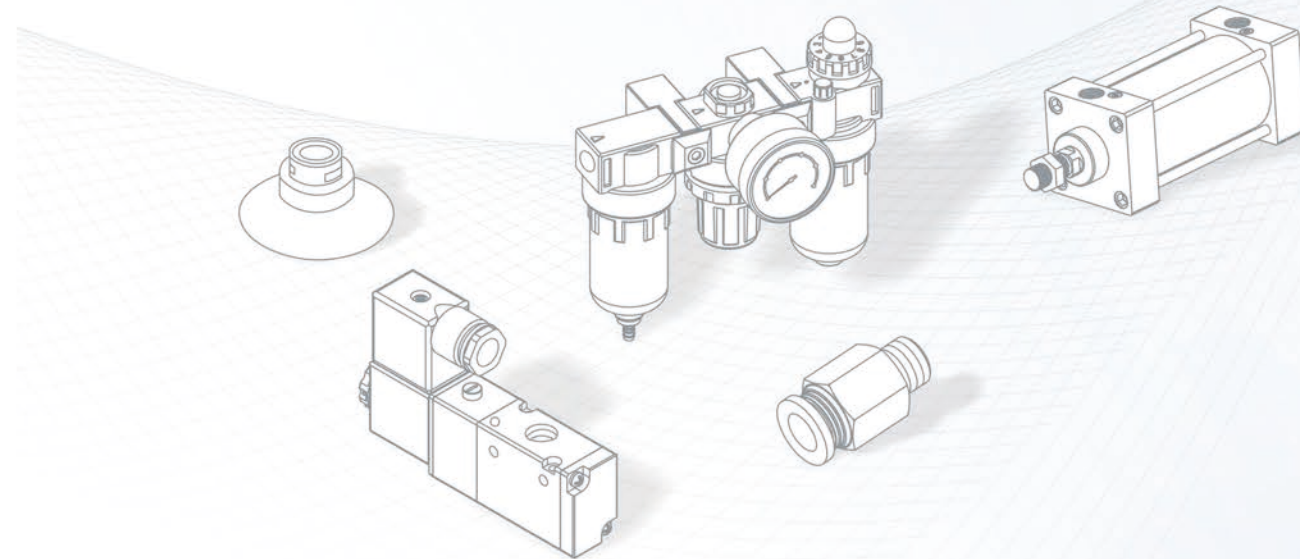

产品选型手册

Product Selection Manual

- Executive Components
- Control Components
- Pneumatic Fittings
- Air Combination
- Vacuum Components



浙江裕丰气动有限公司
ZHEJIANG YUFENG PNEUMATIC CO., LTD.

- ✉ Damon@chyf.cn
- ☎ 0086-0577-61727673
- ☎ 0086-15168776779
- 🌐 www.chyf.net.cn

浙江裕丰气动有限公司
ZHEJIANG YUFENG PNEUMATIC CO., LTD.



产品选型手册

Product Selection Manual

- Executive Components
- Control Components
- Pneumatic Fittings
- Air Combination
- Vacuum Components

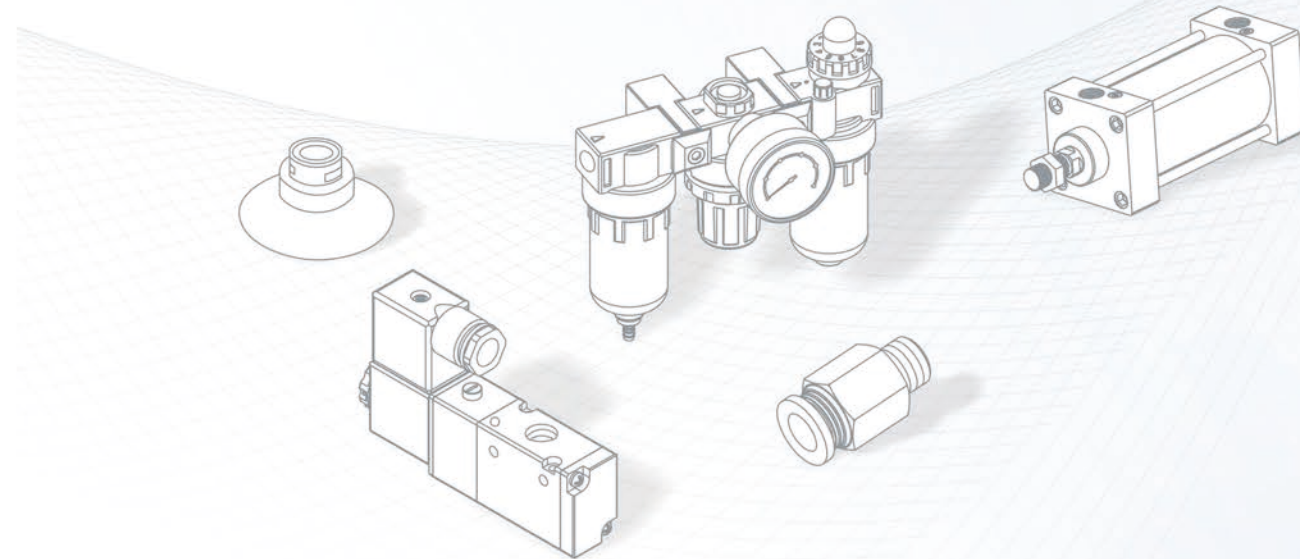

浙江裕丰气动有限公司
ZHEJIANG YUFENG PNEUMATIC CO., LTD.

- ✉ Damon@chyf.cn
- ☎ 0086-0577-61727673
- ☎ 0086-15168776779
- 🌐 www.chyf.net.cn

浙江裕丰气动有限公司
ZHEJIANG YUFENG PNEUMATIC CO., LTD.



Brief Introduction

浙江裕丰气动有限公司，坐落于浙江省乐清市中国电气之都。我们是一家集工业生产和出口为一体的企业，主要生产销售自动化机械配件，涵盖气动接头、气动气缸、气动过滤器、电磁阀、水阀等等。我们致力于提供优质的服务，帮助客户解决自动化机械问题，并为国际自动化出一份绵薄之力。

我们坚持高起点、高质量、高水平的“三高”战略和优良的管理体系，使我们得以稳步发展。我们拥有先进的加工设备，质量可靠，价格优惠，交货准时，深受国内外客户的一致好评。裕丰将不断创新、精益求精，为客户、为社会创造价值，努力把裕丰打造成品牌国际化的世界知名企业。

Yufeng Pneumatic Co., Ltd. is one of the Yufeng Group which is located in China electric city, Yueqing City, Zhejiang. We are integrates industrial manufacturing and exporting, mainly specialized in carious kinds of pneumatic fittings, including Joints/ connectors, Air Cylinders, Air Combinations, Solenoid Valve& etc. Our quality are reliable, with good figure and great price.

We adhere to high starting point, high quality, high level of "three high" strategy and excellent management system, which help us to develop steadily. With good quality, better price and on-time delivery, Yufeng gained praise in both domestic and international market. We also gained the super star company by our government and clients.

For the future, Yufeng will never stop to pursue innovation and refinement as to create values for customers and the society at large, and strives to make it into a world-famous enterprise with modeled operation, scientific management and internationalized brand.

目录 Contents

01	CQ2系列薄型气缸 CQ2 Series compact cylinder CQSB系列薄型气缸 CQSB Series compact cylinder SDA系列薄型气缸 SDA Series compact cylinder ACP系列超薄气缸 ACP Series Thin cylinder	13	CUJ系列自由安装气缸 CUJ Series free Mount Cylinder CU系列多位置安装气缸 CU Series multi-position installation cylinder MK系列多位置固定气缸 MK Series multi-position cylinder fixed RSQ系列安装高度固定型 RSQ Series Fixed installation height
02	JCQ系列薄型气缸 JCQ Series compact cylinder MSQ系列摆动气缸 MSQ Series oscillating cylinder CRA1系列摆动气缸 CRA1 Series oscillating cylinder CRQ2系列摆动气缸 CRQ2 series oscillating cylinder	14	气缸附件 Cylinder accessories
03	CRB2系列摆动气缸 CRB2 Series Vane rotary cylinder CDRB2系列摆动气缸 CDRB2 Series Vane rotary cylinder MGJ系列微型带导杆气缸 MGJ Series Micro guided cylinder MGP系列薄型带导杆气缸 MGP Series thin cylinder with guide rod	15	磁性开关 Magnetic switch
04	MGG系列小型带导杆气缸 MGG series of small guide rod cylinder TDA系列双轴气缸 TDA Series dual-rod cylinder CXS系列双轴气缸 CXS Series dual-rod cylinder STM系列滑台气缸 STM Series Slide Cylinder	16	YFSY系列电磁阀 YFSY Series Solenoid Valve YFSY系列汇流板 YFSY series base plate 2V系列电磁阀 2V Series Solenoid Valve 3V1系列电磁阀 3V1 Series Solenoid Valve
05	CXSW系列双杆气缸 CXSW Series of doule-double rod cylinder SC系列标准气缸 SC Series standard cylinder SU系列标准气缸 SU Series standard cylinder SI系列标准气缸 SI Series standard cylinder	17	3V系列电磁阀 3V Series Solenoid Valve 4V系列电磁阀 4V Series Solenoid Valve 5V系列电磁阀 5V Series Solenoid Valve 3V/4V系列汇流板 3V/4V Series Manifold
06	DNC/SE系列标准气缸 DNC/SE Series standard cylinder MBB系列标准气缸 MBB Series standard cylinder CA2系列标准气缸 CA2 Series standard cylinder MAL系列铝合金迷你气缸 MAL Series slim cylinder	18	4M系列电磁阀 4M Series Solenoid Valve VF3系列电磁阀 VF3 Series Solenoid Valve VF5系列电磁阀 VF5 Series Solenoid Valve 6VSC系列电磁阀 6VSC Series Solenoid Valve
07	MA系列不锈钢迷你气缸 MA Series Stainless Steel Mini Cylinder CM2系列不锈钢迷你气缸 CM2 Series Stainless Steel Mini Cylinder C85系列不锈钢迷你气缸 C85 Series Stainless Steel Mini Cylinder CDJ2B系列不锈钢迷你气缸 CDJ2B Series Stainless Steel Mini Cylinder	19	3A/4A系列气控阀 3A/4A series air control valve 3H/4H系列手扳阀 3H/4H Series manual valve 3R/4R系列手拉阀 3R/4R Series manual valve 4HV系列手转阀 4HV Series Hand-switching valve
08	CJ2系列不锈钢迷你气缸 CJ2 Series Stainless Steel Mini Cylinder CDJ2KB系列不锈钢迷你气缸 CDJ2KB Series Stainless Steel Mini Cylinder CG1系列轻巧型气缸 CG1 Series compact cylinder CJP(单作用)系列针型气缸 CJP(Single acting)Series pin cylinder	20	4F210系列脚踏阀 4F210 series foot valve FV320/420系列脚踏阀 FV320/420 Series foot valve KG系列手滑阀 KG Series Hand slide valve XQ系列快速排气阀 XQ Series quick exhaust valve
09	CJP(双作用)系列针型气缸 CJP(Double-acting)Series pin cylinder CJP2(双作用)系列针型气缸 CJP2(Double Acting) Series Needle Cylinder CY3B系列无杆气缸 CY3B Series rodless cylinder CY3R系列无杆气缸 CY3R Series rodless cylinder	21	JM322系列机械阀 JM322 Series Control JMJ系列机械阀 JMJ Series Control MV322系列机械阀 MV322 Series Control
10	CY3S系列无杆气缸 CY3S Series rodless cylinder CY3L系列无杆气缸 CY3L Series rodless cylinder MHZ2系列气动手指 MHZ2 Series pneumatic finger MHC2系列气动手指 MHC2 Series pneumatic finger	22	MV522系列机械阀 MV522 Series Control MOV321系列机械阀 MOV Series Control ASC系列单向节流阀 ASC Series Flow control valve RE系列流量控制阀 RE Series Flow control valve QE系列快速排气阀 QE Series Quick Exhaust Valve
11	MHL2系列气动手指 MHZ2 Series pneumatic finger MHY2系列气动手指 MHZ2 Series pneumatic finger MHS系列气爪 MHS Series Air Gripper MXS系列气动滑台 MXS Series Pneumatic Slider	23	SMC型气源处理器 SMC Type Air Treatment Components
12	MXQ系列气动滑台 MXQ Series Pneumatic Slider MXH系列小型精密气动滑台 MXH Series Small Pneumatic Slide MXP系列小型精密气动滑台 MXP Series Small Precise Pneumatic Slide MXF系列超薄型气动滑台 MXF Series compact Pneumatic Slide	24	亚德客型气源处理器 AirTAC Type Air Treatment Components
		25	MAR系列精密调压阀 MAR Series Precise regulator DSP-2系列数显压力表 DSP-2 Series Digital Pressure Gauge DSP-3系列数显压力表 DSP-3 Series Digital Pressure Gauge DSP-5系列数显压力表 DSP-5 Series Digital Pressure Gauge
		26	接头系列 Connector Series
		32	真空发生器 Vacuum generator 消声器 Muffler 剪管器 Shear Hose PU管 PU tube
		33	缓冲器系列 Buffer Series
		34	真空元件系列 Vacuum Series

CQ2系列薄型气缸 CQ2 Series compact cylinder

产品图片 Product picture	CDQ2	B	40 × 50	-	N	D	M
	系列号 Series Code	安装型式 Installation Type	缸径 Bore	行程 Stroke	空白:无可调(标准型) Blank: No adjustable (Standard type)	动作型式 Action type	可选项 Options
	CQ2:无内置磁环 CQ2:without magnet CDQ2:内置磁环 CDQ2:with magnet	B:通孔及两端螺孔 共用(标准型) B:screw hole and both ends of the common (standard)	12 40 16 50 20 63 25 80 32 100	10:10mm 20:20mm 30:30mm 40:40mm 50:50mm	N:可调行程距离 10:10mm 20:20mm 30:30mm 40:40mm 50:50mm	D:双动型 S:单动(预缩型) T:单动(预伸型) D:double acting S:single acting (spring return type) T:single acting (spring stretched type)	空白:杆端内螺纹(标准型) M:杆端外螺纹 C:橡胶缓冲 *单动气缸不可加橡胶缓冲 Blank: Rod end female thread (standard) M: Rod end male thread C: Rubber buffer *Single action cylinder can not increase the rubber buffer

CQSB系列薄型气缸 CQSB Series compact cylinder

产品图片 Product picture	CDQS	B	20 × 50	-	D	M
	系列号 Series Code	安装型式 Installation Type	缸径 Bore	行程 Stroke	动作型式 Action type	杆端螺纹 Rod end thread
	CQS:无内置磁环 CDQS:内置磁环 CQS:without magnet CDQS:with magnet	B:通孔(标准型) L:脚架型 F:杆侧法兰型 G:无杆侧法兰型 D:双耳环型 L:Foot type F: Rod side flange type G: No Rod side flange type D: Prong Type	12 16 20 25		D:双动型 S:单动(预缩型) T:单动(预伸型) D:double acting S:single acting (spring return type) T:single acting (spring stretched type)	空白:内螺纹(标准型) M:外螺纹 Blank: Internal thread (standard) M: External thread

SDA系列薄型气缸 SDA Series compact cylinder

产品图片 Product picture	SDA	S	40 × 50	-	N	B
	系列号 Series Code	磁石代号 Built-in magnets	缸径 Bore	行程 Stroke	空白:无可调(标准型) Blank: No adjustable (Standard type)	杆端螺纹 Rod end thread
	SDA:复动型 SDAD:双轴型 SDAJ:双轴可调型 SDAT:多位置复动型 SDAD:Bi-axial type SDAJ:both sides piston rod type (one side adjustable) SDAT:multi-position Double Action	空白:不附磁 S:附磁石 Blank:without S:with	12 40 16 50 20 63 25 80 32 100		N:可调行程距离 10:10mm 20:20mm 30:30mm 40:40mm 50:50mm	空白:内螺纹 B:外螺纹 N:无螺纹 Blank: Internal thread B: external thread N: No thread

ACP系列超薄气缸 ACP Series Thin cylinder

产品图片 Product picture	ACP	-	S	40 × 50	-	□
	系列号 Series Code	磁石代号 Built-in magnets	缸径 Bore	行程 Stroke	固定型式 Fixed form	
	ACP:紧凑型气缸(复动型) ASP:紧凑型气缸(单动伸出型) ATP:紧凑型气缸(单动引入型) ACPD:紧凑型气缸(双轴复动型) ACP:紧凑型气缸(双轴可调行程型) ASP: Compact cylinder (single acting intrusion type) ATP: Compact cylinder (single acting introducing type) ACPD: Compact cylinder (T Double acting) ACP: Compact cylinder (T Double acting Stroke adjustable type)	空白:不附磁 S:附磁石 Blank:without S:with	12 40 16 50 20 63 25 80 32 100		FA:前法兰连接板 FB:后法兰连接板 CA:单耳固定座 CB:双耳固定座 LB:轴向固定座 FA: front flange connecting plate FB: Flange connection plate CA: monaural holder CB: binaural holder LB: axial holder	

JCQ系列薄型气缸 JCQ Series compact cylinder

产品图片 Product picture	JCQ	□	12	□ × 30	-	M9BW	□
	系列号 Series Code	安装型式 Installation Type	缸径 Bore	行程 Stroke	磁性开关型号 Magnetic switch model	磁性开关追记号 Without auto switch	
	JCQ:无内置磁环 JCQ:without magnet JCDQ:内置磁环 JCDQ:with magnet	无记号:通孔(标准) A:两端通孔 Blank:Through (Standard) A:Through hole and both ends	12 40 16 50 20 63 25 80 32 100		无记号:无磁性开关 Blank:non-magnetic switch	无记号:2个:Blank S:1个 n:n个 Blank:2 S:1 n:n	

通口螺纹种类
Types of through threads
无记号:M螺纹(φ12-40)/Rc(φ50-100)
TN:NPT(φ50-100)
TF:G(φ50-100)
Blank:M Thread(φ12-40)/Rc(φ50-100)
TN:NPT(φ50-100)
TF:G(φ50-100)

MSQ系列转台型齿杆式回转摆动气缸 MSQ Series turntable swivel rotary cylinder-type gear lever

产品图片 Product picture	MSQB	□	-	A	-	E
	系列号 Series Code	大小代号 Size Code	可选项 Options	连接端口位置 Connected through the port position		
	MSQA:高精度型 MSQB:基本型 MSQA: High-precision type MSQB: Basic	10 70 20 100 30 200 50	A:带调角度螺栓 R:带油压缓冲器 A:with the angle adjustment bolt R:with shock absorber	空白:侧面 E:正面 Blank: Side E: Positive		

CRA1系列齿轮齿条式摆动气缸 CRA1 Series Rack and pinion type oscillating cylinder

产品图片 Product picture	CDRA1	B	W	U	50	-	90
	系列号 Series Code	安装型式 Installation Type	轴型式 Shaft type	空白:无角度调节单元 Blank: Without adjustable parts	缸径 Bore	摆动角度 Swing angle	
	CRA1:无内置磁环 CDRA1:内置磁环 CRA1:without magnet CDRA1:with magnet	B:基本型 A:脚座型 F:法兰型 A:foot bracket type F:flange type	S:单轴 W:双轴 S:single shaft W:double shaft	U:带角度调节单元 U:with angle adjustable parts	30:φ30mm 50:φ50mm 63:φ63mm 80:φ80mm 100:φ100mm	90:90° 180:180°	

CRQ2系列薄型摆动气缸(齿轮齿条式) CRQ2 series of thin swing cylinder (rack and pinion)

产品图片 Product picture	CDRQ2	B	S	20	90	-	C
	系列号 Series Code	安装型式 Installation Type	轴型式 Shaft Type	缸径 Bore	摆动角度 Swing angle	任选 Optionally	
	CRQ2:基本型 CDRQ2:内置磁环 CRQ2:Basic CDRQ2:with magnet	B:基本型 B:basic type	S:单轴(只限于φ20,φ30,φ40) W:双轴 S: single (only φ20, φ30, φ40) W: biaxial	10:φ10mm 15:φ15mm 20:φ20mm 30:φ30mm 40:φ40mm	90:90° 180:180°	无记号:无缓冲 C:气缓冲(只限于φ20,φ30,φ40) D:用D-90AL, D-93AL磁性开关(只限于φ10, φ15)	

执行元件
磁性开关
控制元件
空气过滤器
接头系列
接头、气管系列
缓冲器系列
真空元件系列

CRB2系列叶片式摆动气缸 CRB2 Series Vane rotary cylinder

产品图片 Product picture



CRB2 B W U 10 180 S E

- 系列号 Series Code**
CRB2:基本型
CRB2:Basic
- 安装型式 Installation type**
B:基本型
*F:法兰型
B:Basic
*F:Flange
*Φ40无F
*Φ40 No F
- 轴型式 Shaft type**
W 双轴一面铣平 (Φ10~Φ30)
长轴带键
短轴一面铣平 (Φ40)
W Biaxial Sidemilling(Φ10~Φ30)Keyed long axis
Minor sidemilling(Φ40)
- 角度调整单元 Angle adjusting means**
无记号:无
U:带
Nil:None
U:with
- 缸径 Bore**
Φ10
Φ15
Φ20
Φ30
Φ40
- 叶片形式 Leaf form**
S:单叶片
D:双叶片
S:Single blade
D:Double blade
- 接管位置 Nozzle position**
无记号:
缸体侧面
E:缸体轴向
Nil:cylinder side
E:cylinder axial

摇动角度 Rocking angle

单叶片 Single Leaf	记号 Sign	摇动角度 Rocking angle
	90	90°
	180	180°
	270	270°
双叶片 Double Leaf		
	90	90°
	100	100°

CDRB2系列叶片式摆动气缸 CDRB2 Series Vane rotary cylinder

产品图片 Product picture



CDRB2 B W U 20 180 S

- 系列号 Series Code**
CDRB2:带磁性开关
CDRB2:with magnetic switch
- 安装型式 Installation type**
B:基本型
*F:法兰型
B:Basic
*F:Flange
*Φ40无F
*Φ40 No F
- 轴型式 Shaft type**
W 双轴一面铣平 (Φ10~Φ30)
长轴带键
短轴一面铣平 (Φ40)
W Biaxial Sidemilling(Φ10~Φ30)Keyed long axis
Minor sidemilling(Φ40)
- 角度调整单元 Angle adjusting means**
无记号:无
U:带
Nil:None
U:with
- 缸径 Bore**
Φ10
Φ15
Φ20
Φ30
Φ40
- 摇动角度 Rocking angle**
- 叶片形式 Leaf form**
S:单叶片
D:双叶片
S:Single blade
D:Double blade

摇动角度 Rocking angle

单叶片 Single Leaf	记号 Sign	摇动角度 Rocking angle
	90	90°
	180	180°
	270	270°
双叶片 Double Leaf		
	90	90°
	100	100°

MGJ系列微型带导杆气缸 MGJ Series Micro guided cylinder

产品图片 Product picture



MGJ 6 - 10

- 系列号 Series Code**
- 缸径 Bore**
6
10
- 行程 Stroke**

MGP系列薄型带导杆气缸 MGP Series thin cylinder with guide rod

产品图片 Product picture



MGP M 25 - 40

- 系列号 Series Code**
MGP:内置磁环
MGP:with magnet
- 轴承种类 Bearing Type**
M:滑动轴承
L:滚珠导向轴承
M-Bearing
L-Ball bearing guide
- 缸径 Bore**
12 40
16 50
20 63
25 80
32 100
- 行程 Stroke**

MGG系列小型带导杆气缸 MGG series of small guide rod cylinder

产品图片 Product picture



MGG M B 32 × 100 - R

- 系列号 Series Code**
MGG:内置磁环
MGG:with magnet
- 轴承种类 Bearing Type**
M:滑动轴承
L:滚珠导向轴承
M:sliding bearing
L:ball guide bearing
- 安装型式 Installation Type**
B:基本型
F:法兰型
B:the basic model
F:flange type
- 缸径 Bore**
20
25
32
40
50
63
80
100
- 行程 Stroke**
- 调整尾板 Regulating the tail plate**
空白:无调程尾板
R:带调程尾板
Blank:without regulating the tail plate
R:tail plate with adjustable range

TDA系列双轴气缸 TDA Series dual-rod cylinder

产品图片 Product picture



TDA 25 × 50 - S

- 系列号 Series Code**
TN:双轴复动型
TND:双轴双头型
TN:double-shaft double action type
TND: Dual-axis type
- 缸径 Bore**
10
16
20
25
32
- 行程 Stroke**
- 磁石代号 Built-in magnets**
空白:不附磁
S:附磁石
Blank:without
S:with

CXS系列双轴气缸 CXS Series dual-rod cylinder

产品图片 Product picture



CXS M 20 × 100 - Y59A

- 系列号 Series Code**
CXs:双轴复动型
CXs:double-shaft double action type
- 轴承种类 Bearing Type**
M:滑动轴承
L:滚珠导向轴承
M:Sliding bearing
L:Ball guide bearing
- 缸径 Bore**
6
10
15
20
25
32
- 行程 Stroke**
- 磁性开关型号 Magnetic switch model**
空白:无磁性开关
Blank:non-magnetic switch

STM系列滑台气缸 STM Series Slide Cylinder

产品图片 Product picture



STM B 25 × 100 - □

- 系列号 Series Code**
STM:复动型
STM:Double Action
- 固定型式 Fixed type**
B:本体固定型
S:滑块固定型
B:Body fixed
S:Sliding block
- 缸径 Bore**
10
16
20
25
- 行程 Stroke**
- 螺纹代码 Thread code**
空白:PT螺纹
T:NPT螺纹
G:G螺纹
Blank:PT thread
T:NPT thread
G:G thread

Actuator Components
执行元件
磁性开关
Control Components
控制元件
Air combination
空气过滤组合
Connector Series
接头系列
Connector, Indicators Series
接头、气管系列
Buffer Series
缓冲器系列
Vacuum Series
真空元件系列

CXSW 系列双联双出杆气缸 CXSW Series of double-double rod cylinder

产品图片 Product picture	CXSW	M	20 × 50	□	Y59A	
	系列号 Series Code CXSW:内置磁环 CXSW:with magnet	轴承种类 Bearing Type M:滑动轴承 L:滚珠导向轴承 M:Sliding bearing L:Ball guide bearing	缸径 Bore 6 10 15 20 25 32	行程 Stroke	长行程代号 Longprocess ID 空白:标准行程 XB11:长行程 Blank:Standard stroke XB11-long stroke	磁性开关型号 Magnetic switch model 空白:无磁性开关 Blank:non-magnetic switch

SC系列标准气缸 SC Series standard cylinder

产品图片 Product picture	SC	50 × 100	- N	S	FA	
	系列号 Series Code SC:标准复动型(拉杆式) SCD:双轴型标准气缸 SCJ:双轴可调型标准气缸 SCT:多位可调型标准气缸 SCD:Standard double-shaft, double acting SCJ:Double-shaft with adjustable stroke SCT:multi-position double action	缸径 Bore 32 40 50 63 80 100	行程 Stroke 空白:无可调(标准型) N:可调行程距离 10:10mm 20:20mm 30:30mm 40:40mm 50:50mm 75:75mm 100:100mm	磁石代号 Built-in magnets 空白:不附磁 S:附磁石 Blank:without S:with	固定型式 Fixed type 空白:基本型 CA:后盖固定式(单耳型) CB:后盖固定式(双耳型) FA:前盖固定式(前法兰) FB:后盖固定式(后法兰) LB:脚架式 TC:摇摆式 CA:固定式加脚座 CB:固定式(单耳型) CB:fixed cover(the ears type) FA:fixrd front cover(front flange) FB:fixrd cover(back flange) LB:Tripod type TC:Swing TC-M:swing-plus feet	

SU系列标准气缸 SU Series standard cylinder

产品图片 Product picture	SU	50 × 100	- N	S	FA	
	系列号 Series Code SU:标准复动型(拉杆内藏式) SUD:双轴型标准气缸 SUJ:双轴可调型标准气缸 SUT:多位可调型标准气缸 SUD:Standard double-shaft, double acting SUJ:Double-shaft with adjustable stroke SUT:Multi-position Double Action	缸径 Bore 32 40 50 63 80 100	行程 Stroke 空白:无可调(标准型) N:可调行程距离 10:10mm 20:20mm 30:30mm 40:40mm 50:50mm 75:75mm 100:100mm	磁石代号 Built-in magnets 空白:不附磁 S:附磁石 Blank:without S:with	固定型式 Fixed type 空白:基本型 CA:后盖固定式(单耳型) CB:后盖固定式(双耳型) FA:前盖固定式(前法兰) FB:后盖固定式(后法兰) LB:脚架式 TC:摇摆式 CA:固定式加脚座 CB:固定式(单耳型) CB:fixed cover(the ears type) FA:fixrd front cover(front flange) FB:fixrd cover(back flange) LB:Tripod type TC:Swing TC-M:swing-plus feet	

SI系列标准气缸 SI Series standard cylinder

产品图片 Product picture	SI	50 × 50	- N	S	FA	
	系列号 Series Code SI:标准复动型 SID:双轴复动型 SIJ:双轴可调型 SID:Standard Double Action SIJ:Double-shaft with adjustable stroke	缸径 Bore 32 100 40 125 50 160 63 200 80	行程 Stroke 空白:无可调(标准型) N:可调行程距离 10:10mm 20:20mm 30:30mm 40:40mm 50:50mm 75:75mm 100:100mm	磁石代号 Built-in magnets 空白:不附磁 S:附磁石 Blank:without S:with	固定型式 Fixed type 空白:基本型 CA:后盖固定式(单耳型) CB:后盖固定式(双耳型) FA:前盖固定式(前法兰) FB:后盖固定式(后法兰) LB:脚架式 TC:摇摆式 CA:固定式加脚座 CB:固定式(单耳型) CB:fixed cover(the ears type) FA:fixrd front cover(front flange) FB:fixrd cover(back flange) LB:Tripod type TC:Swing TC-M:swing-plus feet	

DNC/SE系列标准气缸(符合ISO6431标准) DNC/SE Series standard cylinder(standard ISO6431)

产品图片 Product picture	DNC	63 × 100	- N	PPV	A	S2
	系列号 Series Code DNC:基本型 HNC:轴向脚座 FNC:前后法兰 SNCB:双耳座 SNCL:单耳座 DNC:Basic type HNC:foot bracket type FNC:front&rear flange type SNCB:double clevis type SNCL:single clevis type	缸径 Bore 32 40 50 63 80 100	行程 Stroke 空白:无可调(标准型) N:可调行程距离 10:10mm 20:20mm 30:30mm 40:40mm 50:50mm 75:75mm 100:100mm	空白:无缓冲 PPV:带缓冲 Blank:without cushion PPV:with cushion	空白:基本型 A:内置磁环型 Blank:Basic A:Built-in magnetic-type	空白:基本型 (单端活塞杆) S2:双活塞杆 S3:双端活塞杆 (单端活塞杆) S2:double rod S3:piston rod (adjustable type)

MBB系列标准气缸 MBB Series standard cylinder

产品图片 Product picture	MBB	50 × 150	- N	S	FA	
	系列号 Series Code MBB:基本型 MDBB:内置磁环型 MDBB:with magnet	缸径 Bore 32 40 50 63 80 100 125	行程 Stroke 空白:无可调(标准型) N:可调行程距离 10:10mm 20:20mm 30:30mm 40:40mm 50:50mm 75:75mm 100:100mm	磁石代号 Built-in magnets 空白:不附磁 S:附磁石 Blank:without S:with	固定型式 Fixed type 空白:基本型 CA:后盖固定式(单耳型) CB:后盖固定式(双耳型) FA:前盖固定式(前法兰) FB:后盖固定式(后法兰) LB:脚架式 TC:摇摆式 CA:固定式加脚座 CB:固定式(单耳型) CB:fixed cover(the ears type) FA:fixrd front cover(front flange) FB:fixrd cover(back flange) LB:Tripod type TC:Swing TC-M:swing-plus feet	

CA2系列标准气缸 CA2 Series standard cylinder

产品图片 Product picture	CA2	L	□	80 × 100	
	系列号 Series Code CA2:基本型 CDA2:内置磁环型 CA2:Basic CDA2:Built-in magnetic-type	安装型式 Installation Type B:基本型 L:脚座型 F:杆侧法兰型 G:无杆侧法兰型 C:单耳环型 D:双耳环型 E:伸耳轴型 L:Foot type F:Rod side flange type G:No Rod side flange type C:Clevis Type D:Prong Type T:The trunnion type	缸筒材料 Cylinder material 空白:铝筒 F:铁筒 Blank:aluminum tube F:Iron cylinder	缸径 Bore 40 50 63 80 100	行程 Stroke

MAL系列铝合金迷你气缸 MAL Series slim cylinder

产品图片 Product picture	MAL	32 × 50	- S	FA	
	系列号 Series Code MAL:复动型 MALD:双轴型 MALJ:双轴可调型 MALD:double-acting type MALJ:double rod type MALJ:double rod type (one side adjustable)	缸径 Bore 16 20 25 32 40	行程 Stroke	磁石代号 Built-in magnets 空白:不附磁 S:附磁石 Blank:without S:with	固定型式 Fixed type 空白:基本型 FA:前盖固定式(前法兰) FB:后盖固定式(后法兰) LB:脚架式 Blank:wagging tail type CM:Round-tailed U:Flat-tailed FA: front cover(front flange)

Actuator Components 执行元件
Magnetic switch 磁性开关
Control Components 控制元件
Air combination 空气过滤组合
Connector Series 接头系列
Connector, Indias Series 接头、气管系列
Buffer Series 缓冲器系列
Vacuum Series 真空元件系列

MA系列不锈钢迷你气缸 MA Series Stainless Steel Mini Cylinder

产品图片 Product picture	32 × 50		S	FA
	系列号 Series Code	缸径 Bore	行程 Stroke	磁石代号 Built-in magnets
	MA:复动型 MAC:复动缓冲型 MAD:双轴型 MAA:双轴可调型 MAC:Double Action buffered MAD:two axle MAJ:Double Adjustable	16 20 25 32 40 50 63		空白:不附磁 S:附磁石 Blank:without S:with
				固定型式 Fixed type
				空白:基本型 FA:前盖固定式(前法兰) FB:后盖固定式(后法兰) LB:脚架式 Blankwagging tail type CM:圆尾型 U:平尾型 Blankwagging tail type CM:Round-tailed U:Flat-tailed

CM2系列不锈钢迷你气缸 CM2 Series Stainless Steel Mini Cylinder

产品图片 Product picture	CM2	20 × 50		D	FA
	系列号 Series Code	缸径 Bore	行程 Stroke	动作型式 Action type	固定型式 Fixed type
	CM2:无内置 CDM2:内置磁环型 CM2B:复动型 CM2BD:双轴型 CM2BD:双轴可调型 CM2:with built-magnet type CM2B:double-acting type CM2BD:double rod type CM2BJ:double rod type(one side adjustable)	20 25 32 40		D:双动型 S:单动(预缩量) T:单动(预缩量) S:单动(预缩量) T:单动(预缩量) S:单动(预缩量) T:单动(预缩量)	空白:基本型 FA:前盖固定式(前法兰) FB:后盖固定式(后法兰) LB:脚架式 Blankwagging tail type CM:圆尾型 U:平尾型 Blankwagging tail type CM:Round-tailed U:Flat-tailed

C85系列不锈钢迷你气缸 C85 Series Stainless Steel Mini Cylinder

产品图片 Product picture	C85	25 × 50		D	FA
	系列号 Series Code	缸径 Bore	行程 Stroke	动作型式 Action type	固定型式 Fixed type
	C85:无内置 CD85:内置磁环型 C85B:复动型 C85BD:双轴型 C85BD:双轴可调型 C85:with built-magnet type C85B:double-acting type C85BD:double rod type C85BJ:double rod type(one side adjustable)	8 10 12 16 20 25		D:双动型 S:单动(预缩量) T:单动(预缩量) S:单动(预缩量) T:单动(预缩量)	空白:基本型 FA:前盖固定式(前法兰) FB:后盖固定式(后法兰) LB:脚架式 Blankwagging tail type CM:圆尾型 U:平尾型 Blankwagging tail type CM:Round-tailed U:Flat-tailed

CDJ2B系列不锈钢迷你气缸 CDJ2B Series Stainless Steel Mini Cylinder

产品图片 Product picture	CDJ2B	B	10 × 25		S
	系列号 Series Code	安装型式 Installation Type	缸径 Bore	行程 Stroke	动作型式 Action type
	CJ2:复动型 CDJ2:内置磁环型 CJ2D:双轴型 CJ2B:双轴可调型 CDJ2:Built-in magnetic-type CJ2D:axis-type CJ2J:Double Adjustable	B:基本型 F:杆侧法兰式 L:轴向脚座型 B:双耳环型(除Φ6) F:Rod side flange style L:Axial foot type D:Clevis type(except Φ6)	6 10 16		D:双动型 S:单动(预缩量) T:单动(预缩量) S:单动(预缩量) T:单动(预缩量)

CJ2系列不锈钢迷你气缸 CJ2 Series Stainless Steel Mini Cylinder

产品图片 Product picture	CJ2	B	6 × 25		S
	系列号 Series Code	安装型式 Installation Type	缸径 Bore	行程 Stroke	动作型式 Action type
	CJ2:复动型 CDJ2:内置磁环型 CJ2D:双轴型 CJ2B:双轴可调型 CDJ2:Built-in magnetic-type CJ2D:axis-type CJ2J:Double Adjustable	B:基本型 F:杆侧法兰式 L:轴向脚座型 B:双耳环型(除Φ6) F:Rod side flange style L:Axial foot type D:Clevis type(except Φ6)	6 10 16		D:双动型 S:单动(预缩量) T:单动(预缩量) S:单动(预缩量) T:单动(预缩量)

CDJ2KB系列不锈钢迷你气缸 CDJ2KB Series Stainless Steel Mini Cylinder

产品图片 Product picture	CDJ2KB	16	XC10	1197K
	系列号 Series Code	缸径 × 行程 Bore × stroke		1973K 1195K 1197K

CG1系列轻巧型气缸 CG1 Series compact cylinder

产品图片 Product picture	CG1	N	40 × 100	
	系列号 Series Code	缓冲 Buffer	缸径 Bore	行程 Stroke
	CG1B:基本型 CDG1B:内置磁环型 CG1B:Basic CDG1B:Built-in magnetic-type	N:橡胶缓冲 A:气缓冲 N:Rubber buffer A:air cushion	20 25 32 40 50 63 80 100	

CJP(单作用)系列针型气缸 CJP(Single acting)Series pin cylinder

产品图片 Product picture	CJPB	10 × 5		B
	安装型式 Installation Type	缸径 Bore	行程 Stroke	杆端螺纹 Rod end thread
	B:面板安装型 S:内藏安装型 S:Built-in mounting	6 10 15		空白:有螺纹 B:无螺纹 Blank:threaded B:Unthreaded

Actuator Components
执行元件
磁性开关
Control Components
控制元件
Air combination
空气过滤组合
Connector Series
接头系列
Connector, Indicators Series
接头、气管系列
Buffer Series
缓冲器系列
Vacuum Series
真空元件系列

CJP(双作用)系列针型气缸 CJP(Double-acting)Series pin cylinder

产品图片 Product picture



CJPB 10 × 10 D - B

系列号 Series Code
CJPB:基本型
CJPD:单耳环型
CJPF:法兰型
CJPL:脚座型
CJPT:耳轴型
CDJPB:内置磁环型
CJPD:Clevis type
CJPF:Flange type
CJPL:Foot type
CJPT:trunnion type
CDJPB:Built-in magnetic-type

缸径 Bore
6
10
15

行程 Stroke

双作用 Double-acting

杆端螺纹 Rod end thread
空白:有螺纹
B:无螺纹
Blank:threaded
B:Unthreaded

CJP2(双作用)系列新款针型气缸 CJP2(Double Acting)Series New Needle Cylinder

产品图片 Product picture



CDJ2PB B 16 × 20 D - B

内置磁环 Attach Magnet
无记号:无内置磁环
D:内置磁环
Blank:Without Attach Magnet
D:Attach Magnet

安装方法 Installation Form
B:基本型
D:耳环型
T:耳轴型
G:集中配管
Blank:Piping type
T:Trunnion type

缸径 Bore
16
20

行程 Stroke

杆端螺纹 Rod end thread
空白:有螺纹
B:无螺纹
Blank:threaded
B:Unthreaded

CY3B系列磁偶式无杆气缸 CY3B Series of mgnetic dipole-type rodless cylinder

产品图片 Product picture



CY3B 25 - 300

系列号 Series Code
CY3B:基本型(无开关导轨)
(升级磁偶式)
CY3B:Basic(no switch rail type)
(Upgrades magnetic dipole type)

缸径 Bore
6:Φ6mm
10:Φ10mm
15:Φ15mm
20:Φ20mm
25:Φ25mm
32:Φ32mm
40:Φ40mm

接口螺纹种类 Interface thread type
记号 种类 缸径
无记号 M φ6 φ10 φ15
TN NPT φ20 φ25
TF G φ32 φ40

行程 Stroke
Mark kind Bore
Blank M φ6 φ10 φ15
TN NPT φ20 φ25
TF G φ32 φ40

CY3R系列磁偶式无杆气缸 CY3R Series of mgnetic dipole-type rodless cylinder

产品图片 Product picture



CY3R 25 - 300

系列号 Series Code
CY3R:内置磁环直接安装型
(升级磁偶式)
CY3R:built-in magnetic mount directly
(Upgrades magnetic dipole type)

接管方式 Way over
无记号:两侧配管
G:集中配管
Blank:Piping type on both sides
G:Centralized piping type

缸径 Bore
6:Φ6mm
10:Φ10mm
15:Φ15mm
20:Φ20mm
25:Φ25mm
32:Φ32mm
40:Φ40mm

接口螺纹种类 Interface thread type
记号 种类 缸径
无记号 M φ6 φ10 φ15
TN NPT φ20 φ25
TF G φ32 φ40

行程 Stroke
Mark kind Bore
Blank M φ6 φ10 φ15
TN NPT φ20 φ25
TF G φ32 φ40

空白:带开关导轨
N:无开关导轨
*N式仅对标准型
*开关导轨内置磁石
Blank:with switch rail
N:no switch rail
*N-type only standard
*Built-in magnet switch rail

CY3S系列磁偶式无杆气缸 CY3S Series of mgnetic dipole-type rodless cylinder

产品图片 Product picture



CDY3S 25 H - 300 A73

开关导轨 Switch rail
无记号:无
O:有
基本型无D式
Blank:Without
O:With
Basic type without D

缸径 Bore
6:Φ6mm
10:Φ10mm
15:Φ15mm
20:Φ20mm
25:Φ25mm
32:Φ32mm
40:Φ40mm

接口螺纹种类 Interface thread type
记号 种类 缸径
无记号 M φ6 φ10 φ15
TN NPT φ20 φ25
TF G φ32 φ40

行程 Stroke
Mark kind Bore
Blank M φ6 φ10 φ15
TN NPT φ20 φ25
TF G φ32 φ40

接管方式 Way over
无记号:两侧配管
G:集中配管
Blank:Piping type on both sides
G:Centralized piping type

调整型式 Adjustment in the form
空白:带调程螺钉(2个)
B:带油压缓冲器(2个)
Blank:With bolt adjustment process(2)
B:with hydraulic shock absorbers(2)
BS:带油压缓冲器(1个)
BS:with hydraulic shock absorbers(1)

磁性开关型号 Magnetic switch model
空白:无磁性开关
Blank:non-magnetic switch

CY3L系列磁偶式无杆气缸 CY3L Series of mgnetic dipole-type rodless cylinder

产品图片 Product picture



CY3L 25 - 300 A73

系列号 Series Code
CY3L:滑尺型(球轴承)
CY3L:slider-type(ball bearing)

缸径 Bore
6:Φ6mm
10:Φ10mm
15:Φ15mm
20:Φ20mm
25:Φ25mm
32:Φ32mm
40:Φ40mm

接口螺纹种类 Interface thread type
记号 种类 缸径
无记号 M φ6 φ10 φ15
TN NPT φ20 φ25
TF G φ32 φ40

行程 Stroke
Mark kind Bore
Blank M φ6 φ10 φ15
TN NPT φ20 φ25
TF G φ32 φ40

调整型式 Adjustment in the form
空白:带调程螺钉(2个)
B:带油压缓冲器(2个)
Blank:With bolt adjustment process(2)
B:with hydraulic shock absorbers(2)
BS:带油压缓冲器(1个)
BS:with hydraulic shock absorbers(1)

磁性开关型号 Magnetic switch model
空白:无磁性开关
Blank:non-magnetic switch

MHZ2系列气动手指 MHZ2 Series pneumatic finger

产品图片 Product picture



MHZ2 16 D

系列号 Series Code
MHZ2:平行开闭型
MHZ2:parallel to the opening and closing type

缸径 Bore
6:Φ6mm
10:Φ10mm
15:Φ15mm
20:Φ20mm
25:Φ25mm
30:Φ30mm
40:Φ40mm

动作型式 Action type
D:双动
S:单动(常开)
C:单动(常闭)
D:double action
S:single acting (normally open)
C:single action (normally closed)

手指型式 Finger type
空白:标准
N:窄型
Blank:Standard
N:Narrow
注:窄型(N)不适用于缸径Φ32mm及Φ40mm以上

防尘胶套材料 Dust sleeve material
空白:氯丁橡胶(CR)
F:氟化橡胶(FKM)
S:硅胶(Si)
Blank:chloroprene rubber(CR)
F:fluorinated rubber(FKM)
S:silica(Si)

MHC2系列气动手指 MHC2 Series pneumatic finger

产品图片 Product picture



MHC2 20 S

系列号 Series Code
MHC2:支点开关型
MHC2:fulcrum switching

缸径 Bore
6:Φ6mm
10:Φ10mm
15:Φ15mm
20:Φ20mm
30:Φ30mm
40:Φ40mm

动作型式 Action type
D:双动
S:单动(常开)
C:单动(常闭)
D:double action
S:single acting (normally open)
C:single action (normally closed)

手指型式 Finger type
空白:标准
N:窄型
Blank:Standard
N:Narrow
注:窄型(N)不适用于缸径Φ32mm及Φ40mm以上

防尘胶套材料 Dust sleeve material
空白:氯丁橡胶(CR)
F:氟化橡胶(FKM)
S:硅胶(Si)
Blank:chloroprene rubber(CR)
F:fluorinated rubber(FKM)
S:silica(Si)

执行元件
磁性开关
控制元件
空气过滤组合
接头系列
接头、气管系列
缓冲器系列
真空元件系列

MHL2系列阔型气动手指(平行开闭型) MHL2 series of wide type pneumatic finger(parallel to open and close type)

产品图片 Product picture



MHL2 - 16 D 1 - Y59A

- 系列号 Series Code**
MHL2:平行开闭型
MHL2:parallel switching
- 缸径 Bore**
10:Φ10mm
16:Φ16mm
20:Φ20mm
25:Φ25mm
32:Φ32mm
40:Φ40mm
- 动作型式 Action type**
D:双作用
D:double action
- 手指开闭行程 Finger opening and closing stroke**
缸径 Φ10 Φ16 Φ20 Φ25 Φ32 Φ40
无记号 20 30 40 50 70 100
1 40 60 80 100 120 160
2 60 80 100 120 160 200
- 磁性开关型号 Magnetic switch**
空白:无磁性开关
*磁性开关型号后面, 附导线长度表示记号:
无记号-0.5m,L-3m,
例:Y59A Y59AL
*magnetic switch type,
The length of the wire attached to said mark:
No mark-0.5m,L-3m,
Example:Y59A Y59AL

MHY2系列气爪(支点开闭型)/凸轮式180°开闭 MHY2 Series Gripper(pivot open and close type)/180° aam opening and closing

产品图片 Product picture



MHY2 - 16 D 2 - M9NL

- 系列号 Series Code**
MHY2:支点开闭型
MHY2:pivot open close
- 缸径 Bore**
10:Φ10mm
16:Φ16mm
20:Φ20mm
25:Φ25mm
- 动作型式 Action type**
D:双作用
D:double action
- 手指安装 Finger mounted**
空白:螺孔安装(标准)
2:开闭方向通孔安装
Installation(standard)
2:opening and closing
Direction through hole mounting
- 磁性开关型号 Magnetic switch**
空白:无磁性开关
*磁性开关型号后面, 附导线长度表示记号:
无记号-0.5m,L-3m,
例:Y59A Y59AL
*magnetic switch type,
The length of the wire attached to said mark:
No mark-0.5m,L-3m,
Example:Y59A Y59AL

MHS2 Series Gripper(pivot open and close type)/180° aam opening and closing

MHS系列气爪(平行开闭型)/圆柱型爪体 MHS Series Air Gripper (parallel opening and closing type)/Cylindrical Claw Body

产品图片 Product picture



MHS2 - 40 - M9N

- 系列号 Series Code**
2 Claws
3 Claws
4 Claws
- 缸径 Bore**
16:Φ16mm
20:Φ20mm
25:Φ25mm
32:Φ32mm
40:Φ40mm
50:Φ50mm
63:Φ63mm
80:Φ80mm
100:Φ100mm
125:Φ125mm
- 磁性开关型号 Magnetic switch**
无记号:无磁性开关
Blank:no magnetic switch
- 磁性开关个数 Without auto switch**
无记号:2个:Blank
S:1个
Blank:2
S:1

MXS系列气动滑台(十字滚柱导轨)/双缸型 MXS Series Pneumatic Slider (cross roller guide)/Double Cylinder Type

产品图片 Product picture



MXS - 12 50 - M9N

- 系列号 Series Code**
- 缸径 Bore**
6
8
12
16
20
25
- 行程 Stroke**
- 调整装置 Adjustment Device**
无记号 无
AS: 前端调程
AT: 后端调程
A: 两端调程
*BS: 前端液压缓冲器
*BT: 后端液压缓冲器
Blank No
AS: Front end adjustment
AT: Back end adjustment
A: Both ends
*BS: Front end hydraulic buffer
*BT: Rear end hydraulic buffer
*MXS: Hydraulic buffer at both ends
- 功能可选项 Function options**
无记号: 无
F: 带弹簧缓冲
*R: 带端锁
P: 轴向接管
*FR: 带弹簧缓冲及端锁
*MXS: 带弹簧缓冲及轴向接管
Blank No
F: With spring buffer
*R: With end lock
P: Axial Pipe
*FR: With spring buffer and end lock
*MXS: With spring buffer and axial connection
- 磁性开关型号 Magnetic switch**
无记号:无磁性开关
Blank:no magnetic switch
- 磁性开关个数 Without auto switch**
无记号:2个:Blank
S:1个
n:n个
Blank:2
S:1
n:n

MXQ系列气动滑台(循环式直线导轨)/双缸型 MXQ Series Pneumatic Slider (circular linear guide)/Double Cylinder Type

产品图片 Product picture



MXQ - 12 L 50 - AS - FR M9N

- 缸径 Bore**
6 16
8 20
12 25
- 行程 Stroke**
无记号-标准型
L-对称型
Blank-Standard Type
L-Symmetrical Type
- 调整装置 Adjustment Device**
无记号 无
AS: 前端
AT: 后端
A: 两端
BS: 前端
BT: 后端
B: 两端
CS: 前端
CT: 后端
C: 两端
Blank No
AS: Front end
AT: Rear end
A: Both ends
BS: Front end
BT: Rear end
B: Both ends
CS: Front end
CT: Rear end
C: Both ends
Note 1) Not applicable to MXQ6.
- 功能可选项 Function options**
无记号: 无
F: 带弹簧缓冲
*R: 带端锁
P: 轴向接管
*FR: 带弹簧缓冲及端锁
Blank: 带弹簧缓冲及轴向接管
F: With spring buffer
*R: With end lock
P: Axial Pipe
*FR: With spring buffer and end lock
*MXS: With spring buffer and axial connection
Note 1) Not applicable to MXQ6.
- 磁性开关型号 Magnetic switch**
无记号:无磁性开关
Blank:no magnetic switch
- 磁性开关个数 Without auto switch**
无记号:2个:Blank
S:1个
n:n个
Blank:2
S:1
n:n

MXH系列小型气动滑台(直线导轨) MXH Series Small Pneumatic Slide (linear guide)

产品图片 Product picture



MXH - 10 30 - A93

- 缸径 Bore**
6
10
16
20
- 行程 Stroke**
- 磁性开关型号 Magnetic switch**
无记号:无磁性开关
Blank:no magnetic switch
- 磁性开关个数 Without auto switch**
无记号:2个:Blank
S:1个
Blank:2
S:1

MXP系列小型精密气动滑台 MXP Series Small Precise Pneumatic Slide

产品图片 Product picture



MXP - 12 15 - M9NL

- 缸径 Bore**
6
8
10
12
16
- 行程 Stroke**
- 磁性开关导轨 Magnetic switch**
无记号:带导轨,内置磁环
N:无导轨,无内置磁环
Blank:With guide,with magnet
N:Without guide,without magnet
- 磁性开关型号 Magnetic switch**
无记号:无磁性开关
Blank:no magnetic switch
- 磁性开关个数 Without auto switch**
无记号:2个:Blank
S:1个
n:n个
Blank:2
S:1
n:n
- 调程方法 The process method**
无记号: 橡胶垫调程(两端各0~3mm)
C: 不锈钢调程螺钉
B: 液压缓冲器(两端各0~5mm)
Blank: Adjustment range of rubber pad (0~3mm at both ends)
C: Stainless steel adjustable range screw
B: Shock absorbers(0~5mm at both ends)

MXF系列超薄型气动滑台(十字滚柱导轨) MXF Series compact Pneumatic Slide(roller guide)

产品图片 Product picture



MXF - 12 15 M9N

- 缸径 Bore**
8
12
16
20
- 行程 Stroke**
- 磁性开关型号 Magnetic switch**
无记号:无磁性开关
Blank:no magnetic switch
- 磁性开关个数 Without auto switch**
无记号:2个:Blank
S:1个
n:n个
Blank:2
S:1
n:n

执行元件
磁性开关
控制元件
空气过滤组合
接头系列
接头、气管系列
缓冲器系列
真空元件系列

CUJ系列小型自由安装气缸 CUJ Series of small free Mount Cylinder

产品图片 Product picture	CUJB	4	6	-	S	-	M9N
	系列号 Series Code CUJB:基本型 CDUJB:内置磁环型 CUJB:built-in magnet ring type	缸径 Bore 4:Φ4mm 6:Φ6mm 8:Φ8mm 10:Φ10mm *Φ4mm气缸没有内置磁环型	行程 Stroke 		动作型式 Action type D:双动 S:单动(弹簧压回) D:double action S:Single action(spring back)		磁性开关型号 Magnetic switch 空白:无磁性开关 Blank:no magnetic switch

CU系列多位置安装气缸 CU Series multi-position installation cylinder

产品图片 Product picture	CDU	□	-	10 × 25	-	D
	系列号 Series Code CU:标准型 CDU:内置磁环型 CU:Basic type CDU:with built-magnet type	活塞杆型式 Rod form 空白:基本型 K:不旋转活塞杆 Blank:basic K:non-rotating piston rod	缸径 Bore 6 10 16 20 25 32	行程 Stroke 		动作型式 Action type D:双动型 S:单动(预缩型) T:单动(预伸型) D:double acting S:single acting (spring return type) T:single acting (spring stretched type)

MK系列多位置固定气缸 MK Series multi-position cylinder fixed

产品图片 Product picture	MK	32 × 30	N	-	S
	系列号 Series Code MK:复动止回转型 MSK:单动伸出止回转型 MTK:单动引入止回转型 MKD:双轴复动止回转型 MKJ:双轴复动行程可调止回转型 MSK:single move out check the transition MTK:single move to introduce the check transformation MKD:dual axis complex dynamic check back transformation MKJ:double axle double action stroke adjustable stop rotary type	缸径 Bore 6 10 16 20 25 32	行程 Stroke 	空白:无可调(标准型) N:可调行程距离 10:10mm 20:20mm 30:30mm	磁石代号 Built-in magnets 空白:不附磁 Blank:without S:with

RSQ系列安装高度固定型 RSQ Series Fixed installation height

产品图片 Product picture	RSDQ	B	-	20 × 15	-	D
	系列号 Series Code RSQ:标准型 RSDQ:内置磁环型 RSQ:Standard RSDQ:Built-in magnet type	安装型式 Installation Type B:通孔(标准) A:两端螺孔 B:through-hole(standard) A:both ends of the screw	缸径 Bore 12 16 20 32 40 50	行程 Stroke 		动作型式 Action type D:双作用 B:双作用(内置弹簧) T:单作用(弹簧压出) D:Double acting B:Double acting (innerspring) T:single acting(spring extend)

型号Model	型号Model	型号Model
TC中摆 TC in put	FA\FB法兰 FA\FBFlange	TC脚座 TC foot bracket
		

型号Model	型号Model	型号Model
CA单耳环 CA single clevis	CB双耳环 CB double clevis	中间耳轴座 Intermediate trunnion seat
		

型号Model	型号Model	型号Model
鱼眼接头 Fisheye joint	LB型脚架 (MAL型) LB foot bracket (MAL-type)	LB脚架 LB foot bracket
		

型号Model	型号Model	型号Model
SDB单耳环带座(MAL型) SDB earrings with a single seat(MAL-type)	I型接头 I joint	Y型接头 Y joint
		

Actuator Components 执行元件
Magnetic switch 磁性开关
Control Components 控制元件
Air combination 空气过滤组合
Connector Series 接头系列
Connector/india series 接头、气管系列
Buffer Series 缓冲器系列
Vacuum Series 真空元件系列

<p>型号 Model CS1-U系列磁性开关 CS1-U Series magnetic switch</p>	<p>型号 Model CS1-F系列磁性开关 CS1-F Series magnetic switch</p>	<p>型号 Model CS1-S系列磁性开关 CS1-S Series magnetic switch</p>	<p>型号 Model CS1-G系列磁性开关 CS1-G Series magnetic switch</p>
<p>型号 Model D-A73系列磁性开关 D-A73 Series magnetic switch</p>	<p>型号 Model D-Z73系列磁性开关 D-Z73 Series magnetic switch</p>	<p>型号 Model D-C73系列磁性开关 D-C73 Series magnetic switch</p>	<p>型号 Model D-A93系列磁性开关 D-A93 Series magnetic switch</p>
<p>型号 Model 磁性开关(费斯托型) Magnetic switch(festo type)</p>	<p>型号 Model D-M9B系列磁性开关 D-M9B Series magnetic switch</p>	<p>型号 Model D-F8B系列磁性开关 D-F8B Series magnetic switch</p>	<p>型号 Model 磁性开关绑带 AUto switch tie</p>
<p>型号 Model 磁性开关绑带 AUto switch tie</p>	<p>型号 Model 磁性开关支架 Auto switch bracket</p>	<p>型号 Model 磁性开关支架 Auto switch bracket</p>	<p>型号 Model 磁性开关支架 Auto switch bracket</p>

YFSY系列电磁阀 YFSY Series Solenoid Valve

产品图片 Product picture

YFSY 3 1 2 0 - M5 - DC24V - G

型号代码 Type code	规格 Specification	安装型式 Installation form	接管型式 Take over form	工作电压 Operating Voltage	M:直线式 G:引线式 M:Linear G:Lead
	3 5 7	2:标准 4:板式 2:Standard 4:Panel	C4 C6 C8 C10 M5 G1/8 G3/8	DC12 DC24 AC110 AC220	

电控方式
Electric control
1:单电控
2:双电控
1:position single solenoid
2:position double solenoid

注意: 3000系列直接接管式有C4、C6
5000系列直接接管式有C4、C6、C8
7000系列直接接管式有C8、C10

YFSY系列汇流板 YFSY series base plate

产品图片 Product picture

YFSS5Y - 5 - 20 - 05 - 5

型号代码 Type code	集装箱系列 Container type series	集装箱位数 Container-digit	螺纹种类 Thread type
	3:YFSY3000 5:YFSY5000	2位 20位 *含盖板组件在内 *Including cover assembly including	无记号(Nil):RC OOF:G OON:NPT OOT:NPTF

2V系列电磁阀 2V Series Solenoid Valve

产品图片 Product picture

2V 025 - 08 - □ - 10F

规格代号 Specification Code	标准口径 Standard diameter	接管口径 Port size	接电方式 Power mode	联数代号 Union Code Number
二口二位电磁阀 2/2 way solenoid valves	025:2.5mm	06:G1/8" 08:G1/4"	空白:DIN插座式 I:出线式 BLank:DIN socket I:Grommet	2F:两联 3F:三联 10F:十联 2F:two together 3F:Triple 10F:ten Union

3V1系列电磁阀 3V1 Series Solenoid Valve

产品图片 Product picture

3V 1 - 06 - A - □ - □ - □

规格代号 Specification Code	系列代号 Series Code	接管口径 Port size	标准电压 Standard voltage	接电方式 Power mode	牙型代码 Tooth type codes	阀体识别码 Valve Body identification code
三口二位电磁阀 2/3 way solenoid valves	1:1系列 1:1 Series	06:G1/8" 08:G1/4"	A:AC220V B:DC24V C:AC110V E:AC24V F:DC12V	空白:DIN插座式 I:出线式 BLank:DIN socket I:Grommet	空白:PT牙 T:NPT牙 G:G牙 BLank:PT tooth T:NPT teeth G:G tooth	空白:串联型 D:单体型 BLank:tandem D:haplotype

①:当接管为M5牙时, 此项代码为空。

- 执行元件
Actuator Components
- 磁性开关
Magnetic switch
- 控制元件
Control Components
- 空气过滤组合
Air combination
- 接头系列
Connector Series
- 接头、气管系列
Connector, hoses series
- 缓冲器系列
Buffer Series
- 真空元件系列
Vacuum series

3V系列电磁阀 3V Series Solenoid Valve

产品图片 Product picture	3V	1	-	10	-	06	-	□	-	A	-	□	-	□
----------------------	----	---	---	----	---	----	---	---	---	---	---	---	---	---

规格代号
Specification Code

三口二位电磁阀
2/3 way solenoid valves

电控方式
Electric control

10: 二位单电控
20: 二位双电控
10: two-position single solenoid
20: two-position double solenoid

初始状态
Initial status

NC: 常闭型
NO: 常开型
NC: normally closed
NO: normally open

标准电压
Standard voltage

A: AC220V
B: DC24V
C: AC110V
E: AC24V
F: DC12V

接电方式
connecting type

空白: DIN插座式
I: 出线式
Blank: DIN socket
I: Grommet

牙型代码
Tooth type codes

空白: PT牙
T: NPT牙
G: G牙
Blank: PT tooth
T: NPT teeth
G: G tooth

系列代号
Series Code

1: 100系列
2: 200系列
3: 300系列
1: 100 Series
2: 200 Series
3: 300 Series

接管口径
Port size

06: G1/8"
08: G1/4"
10: G3/8"

①: 二位双电控型无常开、常闭之分, 故此项代码为空白

4V系列电磁阀 4V Series Solenoid Valve

产品图片 Product picture	4V	1	10	-	06	-	A	-	□	-	□
----------------------	----	---	----	---	----	---	---	---	---	---	---

规格代号
Specification Code

五口二位、
五口三位电磁阀
2/5way, 3/5way solenoid valves

系列代号
Series Code

1: 100系列
2: 200系列
3: 300系列
4: 400系列
1: 100 Series
2: 200 Series
3: 300 Series
4: 400 Series

电控方式
Electric control

10: 二位单电控
20: 二位双电控
30C: 三位双电控中位封闭型
30E: 三位双电控中位排气型
30R: 三位双电控中位排气型
20: two-position double solenoid
30C: three dual electrically controlled Closed center
30E: three-position double solenoid Median exhaust type
30R: three-position double solenoid Medium pressure exhaust type

接管口径
Port size

M5: M5
06: PT1/8
08: PT1/4
10: PT3/8
15: PT1/2

接电方式
connecting type

空白: DIN插座式
I: 出线式
Blank: DIN socket
I: Grommet

牙型代码
Tooth type codes

空白: PT牙
T: NPT牙
G: G牙
Blank: PT tooth
T: NPT teeth
G: G tooth

标准电压
Standard voltage

A: AC220V
B: DC24V
C: AC110V
E: AC24V
F: DC12V

①: 当接管为M5牙时, 此项代码为空。

5V系列电磁阀 5V Series Solenoid Valve

产品图片 Product picture	5V	1	10	-	06	-	A	-	□	-	□
----------------------	----	---	----	---	----	---	---	---	---	---	---

规格代号
Specification Code

五口二位、
五口三位电磁阀
2/5way, 3/5way solenoid valves

系列代号
Series Code

1: 100系列
2: 200系列
3: 300系列
4: 400系列
1: 100 Series
2: 200 Series
3: 300 Series

电控方式
Electric control

10: 二位单电控
20: 二位双电控
30C: 三位双电控中位封闭型
30E: 三位双电控中位排气型
30R: 三位双电控中位排气型
20: two-position double solenoid
30C: three dual electrically controlled Closed center
30E: three-position double solenoid Median exhaust type
30R: three-position double solenoid Medium pressure exhaust type

接管口径
Port size

M5: M5
06: PT1/8
08: PT1/4
10: PT3/8

接电方式
connecting type

空白: DIN插座式
I: 出线式
Blank: DIN socket
I: Grommet

牙型代码
Tooth type codes

空白: PT牙
T: NPT牙
G: G牙
Blank: PT tooth
T: NPT teeth
G: G tooth

标准电压
Standard voltage

A: AC220V
B: DC24V
C: AC110V
E: AC24V
F: DC12V

①: 当接管为M5牙时, 此项代码为空。

3V/4V系列汇流板 3V/4V Series Manifold

产品图片 Product picture	3V/4V	100M	-	5F	-	□
----------------------	-------	------	---	----	---	---

型号代码
Type code

系列代号
Series Code

100M: 100系列底座
200M: 200系列底座
300M: 300系列底座
400M: 400系列底座
200M: 200-series dock
300M: 300-series dock
400M: 400-series dock

连数代号
Union Code Number

1F: 1连
2F: 2连
.....
16F: 16连
2F: 2even
.....
16F: 16even

牙型代码
Tooth type codes

空白: PT牙
T: NPT牙
G: G牙
Blank: PT tooth
T: NPT teeth
G: G tooth

①: 100M、200M系列连座数自至16联; 300M系列连座数自至12联; 400M系列连座数自至8联。

4M系列电磁阀 4M Series Solenoid Valve

产品图片 Product picture	4M	1	-	10	-	10	-	A	-	□
----------------------	----	---	---	----	---	----	---	---	---	---

规格代号
Specification Code

五口二位电磁阀
2/5way solenoid valves

系列代号
Series Code

1: 100系列
2: 200系列
3: 300系列
1: 100 Series
2: 200 Series
3: 300 Series

电控方式
Electric control

10: 二位单电控
20: 二位双电控
10: two-position single solenoid
20: two-position double solenoid

接管口径
Port size

M5: M5
06: PT1/8
08: PT1/4
10: PT3/8

标准电压
Standard voltage

A: AC220V
B: DC24V
C: AC110V
E: AC24V
F: DC12V

接电方式
Power mode

空白: DIN插座式
I: 出线式
Blank: DIN socket
I: Grommet

VF3系列电磁阀 VF3 Series Solenoid Valve

产品图片 Product picture	VF3	130	-	4	-	G	-	B	02
----------------------	-----	-----	---	---	---	---	---	---	----

规格代号
Specification Code

线圈及位数
Coil and digit

130: 二位五通单头双位置
230: 二位五通双头双位置
330: 三位五通双头三位封闭型
430: 三位五通双头三位排气型
530: 三位五通双头三位压力型
230: two five-headed double position
330: three five-headed three-position closed
430: three five-headed three-position exhaust type
530: three five-headed three-position pressure type

标准电压
Standard voltage

3: 110VAC
4: 220VAC
5: 24VDC
6: 12VDC

导线型式
Wire form

G: 直出线式
D: DIN插座式
DZ: DIN插座式带灯
G: Grommet straight
D: DIN socket
DZ: DIN socket LIGHT

手动操作
Manual operation

螺纹接口
Port size

02: PT1/4

VF5系列电磁阀 VF5 Series Solenoid Valve

产品图片 Product picture	VF5	120	-	4	-	G	-	B	02
----------------------	-----	-----	---	---	---	---	---	---	----

规格代号
Specification Code

线圈及位数
Coil and digit

120: 二位五通单头双位置
220: 二位五通双头双位置
320: 三位五通双头三位封闭型
420: 三位五通双头三位排气型
520: 三位五通双头三位压力型
220: two five-headed double position
320: three five-headed three-position closed
420: three five-headed three-position exhaust type
520: three five-headed three-position pressure type

标准电压
Standard voltage

3: 110VAC
4: 220VAC
5: 24VDC
6: 12VDC

导线型式
Wire form

G: 直出线式
D: DIN插座式
DZ: DIN插座式带灯
G: Grommet straight
D: DIN socket
DZ: DIN socket LIGHT

手动操作
Manual operation

螺纹接口
Port size

02: PT1/4

6VSC系列电磁阀 6VSC Series Solenoid Valve

产品图片 Product picture	6VSC	220	-	4E2	-	C	-	AC110V
----------------------	------	-----	---	-----	---	---	---	--------

规格代号
Specification Code

本体宽度
Body width

220: 22mm
260: 26mm
300: 30mm

方向线圈
Direction of the coil

4E1: 单线圈
4E2: 双线圈
Single coil
Double coil

位数
Digit

N1: 二位
C: 三位中间位置关闭型
P: 三位中间位置通气型
R: 三位中间位置排气型
C: three-position neutral position closed type
P: three-position intermediate position ventilation type
R: three-position exhaust type intermediate position

标准电压
Standard voltage

DC12V
DC24V
AC24V
AC110V
AC220V
AC380V

50/60HZ
50/60HZ
50/60HZ
50/60HZ

执行元件 Actuator Components
 磁性开关 Magnetic switch
 控制元件 Control Components
 空气过滤组合 Air combination
 接头系列 Connector series
 接头、气管系列 Connector, hoses series
 缓冲器系列 Buffer series
 真空元件系列 Vacuum series

3A/4A系列气控阀 3A/4A series air control valve

产品图片 Product picture	3A	1	10	06	NO
	规格代号 Specification Code 3A:三口二位气控阀 4A:五口二(三)位气控阀 3A:2/3 way air control valve 4A:5/3(2) way air control valve	系列代号 Series Code 1:100系列 2:200系列 3:300系列 4:400系列 1:100 series 2:200 series 3:300 series 4:400 series	气控方法 Air control mode 3A: 10:二位置单气控 20:二位置双气控 4A: 20:二位置单气控 30C:三位置双气控中位封闭型 30E:三位置双气控中位排气型 3A: 20:二位置单气控中位排气型 10:二位置单气控 20:二位置双气控 4A: 30C:三位置双气控中位封闭型 30E:三位置双气控中位排气型 Median exhaust type	接管口径 Port size M5:M5 06:G1/8" 08:G1/4" 10:G3/8" 15:G1/2"	初始状态 Initial status NC:常闭型 NO:常开型 NC:normally closed NO:normally open

①: 二位置型无常开、常闭之分, 故此型代码为空白。

3H/4H系列手扳阀 3H/4H Series manual valve

产品图片 Product picture	3H/4H	2	10	08
	型号代码 Type code 3H:三口二位 4H:五口二位 3H:2/3 way 4H:2/5 way	系列代号 Series Code 1:100系列 2:200系列 3:300系列 4:400系列 1:100 series 2:200 series 3:300 series 4:400 series	位置代号 Location code 10:单双位置 10: Single and double Location	接管口径 Port size 06:G1/8" 08:G1/4" 10:G3/8" 15:G1/2"

3R/4R系列手拉阀 3R/4R Series manual valve

产品图片 Product picture	3R/4R	2	10	08
	型号代码 Type code 3R:三口二位 4R:五口二位 3R:2/3 way 4R:2/5 way	系列代号 Series Code 1:100系列 2:200系列 3:300系列 4:400系列 1:100 series 2:200 series 3:300 series 4:400 series	位置代号 Location code 10:单双位置 10: Single and double Location	接管口径 Port size 06:G1/8" 08:G1/4" 10:G3/8" 15:G1/2"

4HV系列手转阀 4HV Series Hand-switching valve

产品图片 Product picture	4HV	2	30	06	S
	型号代码 Type code	系列代号 Series Code 2:200系列 3:300系列 4:400系列 2:200 series 3:300 series 4:400 series	位置代号 Location code 10:四口二位 30:四口三位 10:2/4 way 30:3/4 way	接管口径 Port size 2系列: 06:G1/8" 2Series: 08:G1/4" 3系列: 08:G1/4" 3Series: 10:G3/8" 4系列: 10:G3/8" 4Series: 15:G1/2"	安装型式 Installation form 空白:阀体安装 S:面板安装 Blank:Body Installation S:Panel Mount

4F210系列脚踏阀 4F210 series foot valve

产品图片 Product picture	4F	2	10	08	L
	型号代码 Type code 4F:二位五通脚踏阀 4F:2/5 way foot valve	系列代号 Series Code 2:200系列 2:200 Series	位置代号 Location code 10:单双位置 10:Single and Double Location	接管口径 Port size 8:G1/4"	型式代码 Type Code 空白:标准型 L:附锁型 F:附罩型 LF:附锁及附罩型 L:with lock type F:attached shield type LF:with lock and shield type

FV320/420系列脚踏阀 FV320/420 Series foot valve

产品图片 Product picture	FV	420
	型号代码 Type code FV:脚踏阀 FV:Foot Valve	系列代号 Series Code 320:三口二位 420:四口二位 320:2/3 way 420:2/4 way

KG系列手滑阀 KG Series Hand slide valve

产品图片 Product picture	KG	22	NW
	型号代码 Type code	接口螺纹 port size 11:1/8" 22:1/4" 33:3/8" 44:1/2"	螺纹型式 Thread form WW:双外牙型 NW:内外牙型 NN:双内牙型 WW:double outertooth type NW:internal and external teeth type NN:double internaltooth type

注: 可定制反向进气型

XQ系列快速排气阀 XQ Series quick exhaust valve

产品图片 Product picture	XQ	170600
	型号代码 Type code	170600:1/4" 171000:3/8" 171500:1/2"

JM322系列机械阀(三口二位) JM322 Series Control (3/2 Way)



JM 32 - 2 R

规格代号
Specification Code
JM型机械阀
JM Series Control

位置代号
Location code
32:二位三通
32:Two position three way

接管口径
Port size
02:G1/4"

按钮形式
Button Form
空白:基本型
R:滚轮型
TB:选择型旋钮
EB:带锁型按钮
PP:平型按钮
PPL:凸型按钮
PB:大圆型按钮

Blank:Common type
R:Roller lever
TB:Selector type
EB:Locked button
PP:Flat type
PPL:Protruding type
PB:Big round button

JMJ系列机械阀(五口二位) MJM Series Control (5/2 Way)



JMJ 52 - 2 R

规格代号
Specification Code
MJM型机械阀
MJM Series Control

位置代号
Location code
32:二位三通
32:Two position three way

接管口径
Port size
02:G1/4"

按钮形式
Button Form
空白:基本型
R:滚轮型
TB:选择型旋钮
EB:带锁型按钮
PP:平型按钮
PPL:凸型按钮
PB:大圆型按钮

Blank:Common type
R:Roller lever
TB:Selector type
EB:Locked button
PP:Flat type
PPL:Protruding type
PB:Big round button

MV322系列机械阀(五口二位) MV322 Series Control (5/2 Way)



MV 32 - 2 R

规格代号
Specification Code
MV型机械阀
MV Series Control

位置代号
Location code
32:二位三通
32:Two position three way

接管口径
Port size
02:G1/4"

按钮形式
Button Form
空白:基本型
R:滚轮型
TB:选择型旋钮
EB:带锁型按钮
PP:平型按钮
PPL:凸型按钮
PB:大圆型按钮

Blank:Common type
R:Roller lever
TB:Selector type
EB:Locked button
PP:Flat type
PPL:Protruding type
PB:Big round button

MV522系列机械阀(三口二位) MV522 Series Control (3/2 Way)



MV 52 - 2 R

规格代号
Specification Code
JM型机械阀
JM Series Control

位置代号
Location code
52:二位三通
52:Two position three way

接管口径
Port size
02:G1/4"

按钮形式
Button Form
空白:基本型
R:滚轮型
TB:选择型旋钮
EB:带锁型按钮
PP:平型按钮
PPL:凸型按钮
PB:大圆型按钮

Blank:Common type
R:Roller lever
TB:Selector type
EB:Locked button
PP:Flat type
PPL:Protruding type
PB:Big round button

MOV321系列机械阀(三口二位) MOV Series Control (3/2 Way)



MOV 32 - 1 R

规格代号
Specification Code
MJM型机械阀
MJM Series Control

位置代号
Location code
32:二位三通
32:Two position three way

接管口径
Port size
01:G1/8"

按钮形式
Button Form
空白:基本型
R:滚轮型
TB:选择型旋钮
EB:带锁型按钮
PP:平型按钮
PPL:凸型按钮
PB:大圆型按钮

Blank:Common type
R:Roller lever
TB:Selector type
EB:Locked button
PP:Flat type
PPL:Protruding type
PB:Big round button

ASC系列单向节流阀
ASC Series Flow control valve



ASC 300 - 10

规格代号
Specification Code
ASC:单向节流阀
ASC:Flow control valve

系列代码
Case size
100:100系列
200:200系列
300:300系列
100:00Series
200:200Series
300:300Series

接管口径
Port size
100系列:06-G1/8"
200系列:08-G1/4"
300系列:10-G3/8"
15-G1/2"
100Series:06-G1/8"
200Series:08-G1/4"
300Series:10-G3/8"
15-G1/2"

RE系列流量控制阀
RE Series Flow control valve



RE 01

规格代号
Specification Code
RE:流量控制阀
RE:Flow control valve

接管口径
Port size
01:1/8"
02:1/4"
03:3/8"
04:1/2"

QE系列快速排气阀
QE Series Quick Exhaust Valve



QE 01

规格代号
Specification Code
QE:快速排气阀
QE:Quick Exhaust Valve

接管口径
Port size
01:1/8"
02:1/4"
03:3/8"
04:1/2"

执行元件
Actuator Components

磁性开关
Magnetic switch

控制元件
Control Components

空气过滤器组合
Air combination

接头系列
Connector Series

接头、气管系列
Connector, hoses series

缓冲器系列
Buffer Series

真空元件系列
Vacuum series

AC系列三联件 AC Series FRL



AC系列二联件 AC series FR.L



AC、BC系列三联件 AC、BC Series FRL



AFC、BFC系列二联件 AFC、BFC Series FR.L



AC	2000	-	02	D
规格代号 Specification Code	壳体尺寸 Case size	接管口径 Port size	排水方式 Drainage patterns	
1000	1000	M5:M5"	空白:手动排水	
2000	2000	02:1/4"	A:差压排水	
3000	3000	03:3/8"	D:自动排水	
4000	4000	04:1/2"	Blank: Differential Drain	
5000	5000	06:3/4"	D: Automatic Drain	
		10:1"		

AC	2010	-	02	D
规格代号 Specification Code	壳体尺寸 Case size	接管口径 Port size	排水方式 Drainage patterns	
1010	1010	M5:M5"	空白:手动排水	
2010	2010	02:1/4"	A:差压排水	
3010	3010	03:3/8"	D:自动排水	
4010	4010	04:1/2"	Blank: Differential Drain	
5010	5010	06:3/4"	D: Automatic	
		10:1"		

BC	3000	D
规格代号 Specification Code	接管口径 Port size	排水方式 Drainage patterns
AC:小型	1500:1/8"	空白:差压排水
BC:中型	2000:1/4"	D:自动排水
AC:Small Size	3000:3/8"	Blank:Differential Drain
BC:Middle Size	4000:1/2"	D:Automatic Drain

BFC	3000	D
规格代号 Specification Code	接管口径 Port size	排水方式 Drainage patterns
AFC:小型	1500:1/8"	空白:差压排水
BFC:中型	2000:1/4"	D:自动排水
AFC:Small Size	3000:3/8"	Blank:Differential Drain
BFC:Middle Size	4000:1/2"	D:Automatic Drain

AW系列调压过滤器 AW Series regulator filter



AF系列空气过滤器 AF series air filter



AFR、BFR系列调压过滤器 AFR、BFR Series regulator filter



AF、BF系列空气过滤器 AF、BF Series air filter



AW	2000	-	02	D
规格代号 Specification Code	壳体尺寸 Case size	接管口径 Port size	排水方式 Drainage patterns	
1000	1000	M5:M5"	空白:手动排水	
2000	2000	02:1/4"	A:差压排水	
3000	3000	03:3/8"	D:自动排水	
4000	4000	04:1/2"	Blank: Differential Drain	
5000	5000	06:3/4"	D: Automatic Drain	
		10:1"		

AF	2000	-	02	D
规格代号 Specification Code	壳体尺寸 Case size	接管口径 Port size	排水方式 Drainage patterns	
1000	1000	M5:M5"	空白:手动排水	
2000	2000	02:1/4"	A:差压排水	
3000	3000	03:3/8"	D:自动排水	
4000	4000	04:1/2"	Blank: Differential Drain	
5000	5000	06:3/4"	D: Automatic	
		10:1"		

BFR	3000	D
规格代号 Specification Code	接管口径 Port size	排水方式 Drainage patterns
AFR:小型	1500:1/8"	空白:差压排水
BFR:中型	2000:1/4"	D:自动排水
AFR:Small Size	3000:3/8"	Blank:Differential Drain
BFR:Middle Size	4000:1/2"	D:Automatic Drain

BF	3000	D
规格代号 Specification Code	接管口径 Port size	排水方式 Drainage patterns
AF:小型	1500:1/8"	空白:差压排水
BF:中型	2000:1/4"	D:自动排水
AF:Small Size	3000:3/8"	Blank:Differential Drain
BF:Middle Size	4000:1/2"	D:Automatic Drain

AL系列油雾器 AL series Lubricator



AR系列调压阀 AR series regulator



AL、BL系列油雾器 AL、BL Series Lubricator



AR、BR系列调压阀 AR、BR Series regulator



AL	2000	-	02
规格代号 Specification Code	壳体尺寸 Case size	接管口径 Port size	
1000	1000	M5:M5"	
2000	2000	02:1/4"	
3000	3000	03:3/8"	
4000	4000	04:1/2"	
5000	5000	06:3/4"	
		10:1"	

AR	2000	-	02
规格代号 Specification Code	壳体尺寸 Case size	接管口径 Port size	
1000	1000	M5:M5"	
2000	2000	02:1/4"	
3000	3000	03:3/8"	
4000	4000	04:1/2"	
5000	5000	06:3/4"	
		10:1"	

BL	3000
规格代号 Specification Code	接管口径 Port size
AL:小型	1500:1/8"
BL:中型	2000:1/4"
AL:Small Size	3000:3/8"
BL:Middle Size	4000:1/2"

BR	3000
规格代号 Specification Code	接管口径 Port size
AR:小型	1500:1/8"
BR:中型	2000:1/4"
AR:Small Size	3000:3/8"
BR:Middle Size	4000:1/2"

执行元件
Actuator Components

磁性开关
Magnetic Switch

控制元件
Control Components

空气过滤组合
Air combination

接头系列
Connector Series

接头、气管系列
Connector, hoses series

缓冲器系列
Buffer Series

真空元件系列
Vacuum Series

MAR系列精密调压阀 MAR Series Precise regulator

产品图片 Product picture



MAR200 K 6A 1K C

规格代号 Specification Code: MAR200 K 6A 1K C

接管口径 Port size: 6A:1/8" 8A:1/4"

设定压力范围 Adjustable Press. Range: 无:0.05~0.85MPa 1K:0.05~0.1MPa 2K:0.05~0.2MPa 3K:0.05~0.3MPa 4K:0.05~0.4MPa

无:不附压力表 C:压力表(PG-40) Blank:Without Pressure gauge C:Pressure gauge(PG-40)

配管口螺纹 Port thread: 无:Rc牙 G:G牙 NPT:NPT牙 Blank:Rc thread G:G thread NPT:NPT thread

支架 Bracket: 无:L型 B:Z型 Blank:L Type 3K:Z Type

接管口径 Port size: 无:标准型 K:逆流型 Blank:Standard K:Backflow function

无:溢流型 Q:非溢流型 Blank:Relieving type Q:Non-relieving type

DSP-2系列数显压力表 DSP-2 Series Digital Pressure Gauge

产品图片 Product picture



DSP2 10 R - N

规格代号 Specification Code: DPS-2:2系列 DPS-2:2Series

测量范围 Measuring range: 10: 100-1000kPa 01: 100-100kPa

压力接口 Pressure interface: R:R1/8接口(M5内螺纹) N:NPT1/8接口(M5内螺纹) G:G1/8(M5内螺纹) R:R1/8" port(M5 thread) N:NPT1/8" port(M5 thread) G:G1/8" port(M5 thread)

输出形式 output mode: N:二路NPN输出 P:二路PNP输出 A:1路NPN+1路4-20mA V:1路NPN+1路1-5V B:1路PNP+1路4-20mA W:1路PNP+1路1-5V P:PNP×2 A:NPN+Analog4-20mA V:NPN+Analog1-5V B:PNP+Analog4-20mA W:PNP+Analog1-5V

选配1 Option 1: M:选配面板 Z:选配L型支架 S:选配S型支架 Blank:Panel Z:L bracket S:S bracket

型号 Model: PCF4-M5 PCF8-M5 PCF12-01 PCF4-01 PCF8-01 PCF12-02 PCF4-02 PCF8-02 PCF12-03 PCF4-03 PCF8-03 PCF12-04 PCF6-M5 PCF8-04 PCF14-03 PCF6-01 PCF10-01 PCF14-04 PCF6-02 PCF10-02 PCF16-03 PCF6-03 PCF10-03 PCF16-04 PCF6-04 PCF10-04 PCF16-06

DSP-3系列数显压力表 DSP-3 Series Digital Pressure Gauge

产品图片 Product picture



DSP3 10 R - X

规格代号 Specification Code: DPS-3:3系列 DPS-3:3Series

测量范围 Measuring range: 10: 100-1000kPa 01: 100-100kPa

压力接口 Pressure interface: R:R1/8接口(M5内螺纹) N:NPT1/8接口(M5内螺纹) G:G1/8(M5内螺纹) R:R1/8" port(M5 thread) N:NPT1/8" port(M5 thread) G:G1/8" port(M5 thread)

输出形式 output mode: X:NPN+PNP输出 X:NPN+PNP

选配1 Option 1: M:选配面板 N:选配面板+防尘罩 Z:选配L型支架 S:选配S型支架 Blank:Panel N:Panel+shield Z:L bracket S:S bracket

型号 Model: PY-4 PY-6 PY-8 PY-10 PY-12 PY-14 PY-16

DSP-5系列数显压力表 DSP-5 Series Digital Pressure Gauge

产品图片 Product picture



DSP5 10 R - V

规格代号 Specification Code: DPS-5:5系列 DPS-5:5Series

测量范围 Measuring range: 01: 100-100kPa 10: 100-1000kPa 20: 100-2000kPa

压力接口 Pressure interface: R:R1/4" 接口(M5内螺纹) N:NPT1/4" 接口(M5内螺纹) G:G1/4" 接口(M5内螺纹) R:R1/4" port(M5 thread) N:NPT1/4" port(M5 thread) G:G1/4" port(M5 thread)

输出形式 output mode: A:1路NPN+1路4-20mA V:1路NPN+1路1-5V B:1路PNP+1路4-20mA W:1路PNP+1路1-5V V:NPN+Analog1-5V B:PNP+Analog4-20mA W:PNP+Analog1-5V

选配1 Option 1: M:选配面板 N:选配面板+防尘罩 Z:选配L型支架 S:选配S型支架 Blank:Panel N:Panel+shield Z:L bracket S:S bracket

型号 Model: PW6-4 PW8-6 PW10-8 PW12-10 PW14-12 PW16-14 PW18-16 PW20-18

<p>PC 系列螺纹直通</p> <p>PC series male straight</p>  <p>型号 Model: PC4-M5 PC8-M5 PC12-01 PC4-01 PC8-01 PC12-02 PC4-02 PC8-02 PC12-03 PC4-03 PC8-03 PC12-04 PC6-M5 PC8-04 PC14-03 PC6-01 PC10-01 PC14-04 PC6-02 PC10-02 PC16-03 PC6-03 PC10-03 PC16-04 PC6-04 PC10-04 PC16-06</p>	<p>PL 系列螺纹弯通</p> <p>PL series male elbow</p>  <p>型号 Model: PL4-M5 PL8-M5 PL12-01 PL4-01 PL8-01 PL12-02 PL4-02 PL8-02 PL12-03 PL4-03 PL8-03 PL12-04 PL6-M5 PL8-04 PL14-03 PL6-01 PL10-01 PL14-04 PL6-02 PL10-02 PL16-03 PL6-03 PL10-03 PL16-04 PL6-04 PL10-04 PL16-06</p>	<p>PB 系列螺纹正三通</p> <p>PB series male branch tee</p>  <p>型号 Model: PB4-M5 PB8-M5 PB12-01 PB4-01 PB8-01 PB12-02 PB4-02 PB8-02 PB12-03 PB4-03 PB8-03 PB12-04 PB6-M5 PB8-04 PB14-03 PB6-01 PB10-01 PB14-04 PB6-02 PB10-02 PB16-03 PB6-03 PB10-03 PB16-04 PB6-04 PB10-04 PB16-06</p>	<p>PD 系列螺纹侧三通</p> <p>PD series male run tee</p>  <p>型号 Model: PD4-M5 PD8-M5 PD12-01 PD4-01 PD8-01 PD12-02 PD4-02 PD8-02 PD12-03 PD4-03 PD8-03 PD12-04 PD6-M5 PD8-04 PD14-03 PD6-01 PD10-01 PD14-04 PD6-02 PD10-02 PD16-03 PD6-03 PD10-03 PD16-04 PD6-04 PD10-04 PD16-06</p>	<p>PX 系列Y型螺纹三通</p> <p>PX series male "Y"</p>  <p>型号 Model: PX4-M5 PX8-M5 PX12-01 PX4-01 PX8-01 PX12-02 PX4-02 PX8-02 PX12-03 PX4-03 PX8-03 PX12-04 PX6-M5 PX8-04 PX14-03 PX6-01 PX10-01 PX14-04 PX6-02 PX10-02 PX16-03 PX6-03 PX10-03 PX16-04 PX6-04 PX10-04 PX16-06</p>
<p>PCF 系列内螺纹直通</p> <p>PCF series male straight</p>  <p>型号 Model: PCF4-M5 PCF8-M5 PCF12-01 PCF4-01 PCF8-01 PCF12-02 PCF4-02 PCF8-02 PCF12-03 PCF4-03 PCF8-03 PCF12-04 PCF6-M5 PCF8-04 PCF14-03 PCF6-01 PCF10-01 PCF14-04 PCF6-02 PCF10-02 PCF16-03 PCF6-03 PCF10-03 PCF16-04 PCF6-04 PCF10-04</p>	<p>PM 系列隔板直通</p> <p>PM series bulkhead union</p>  <p>型号 Model: PM-4 PM-6 PM-8 PM-10 PM-12 PM-14 PM-16</p>	<p>PU 系列直通</p> <p>PU series union straight</p>  <p>型号 Model: PU-4 PU-6 PU-8 PU-10 PU-12 PU-14 PU-16</p>	<p>PE 系列T型三通</p> <p>PE series union tee</p>  <p>型号 Model: PE-4 PE-6 PE-8 PE-10 PE-12 PE-14 PE-16</p>	<p>PV 系列弯通</p> <p>PV series union elbow</p>  <p>型号 Model: PV-4 PV-6 PV-8 PV-10 PV-12 PV-14 PV-16</p>
<p>PY 系列Y型三通</p> <p>PY series union "Y"</p>  <p>型号 Model: PY-4 PY-6 PY-8 PY-10 PY-12 PY-14 PY-16</p>	<p>PZA 系列十字四通</p> <p>PZA series union cross</p>  <p>型号 Model: PZA-4 PZA-6 PZA-8 PZA-10 PZA-12</p>	<p>PK 系列五通</p> <p>PK series five way</p>  <p>型号 Model: PK-4 PK-6 PK-8 PK-10 PK-12 PK-14 PK-16</p>	<p>PG 系列螺纹直通变径</p> <p>PG series straight thread diameter</p>  <p>型号 Model: PG6-4 PG12-8 PG8-6 PG14-12 PG10-8 PG14-10 PG12-10 PG16-14 PG8-4 PG16-12 PG10-6</p>	<p>PEG 系列三通变径</p> <p>PEG series three through reducing</p>  <p>型号 Model: PEG6-4 PEG10-6 PEG8-6 PEG12-8 PEG10-8 PEG14-12 PEG12-10 PEG14-10 PEG8-4 PEG16-14 PEG12-12</p>
<p>PW 系列Y型三通变径</p> <p>PW series Y type three way reducing</p>  <p>型号 Model: PW6-4 PW8-6 PW10-8 PW12-10 PW14-12 PW16-14 PW18-16 PW20-18</p>	<p>PKG 系列五通变径</p> <p>PKG series five through reducing</p>  <p>型号 Model: PKG6-4 PKG12-8 PKG8-6 PKG14-12 PKG10-8 PKG14-10 PKG12-10 PKG16-14 PKG8-4 PKG16-12 PKG10-6</p>	<p>PKB 系列五通变径螺纹</p> <p>PKB series five screw through reducing</p>  <p>型号 Model: PKB6-4-01 PKB8-6-01 PKB8-6-02 PKB10-8-03 PKB12-10-04 PKB10-6-03 PKB12-8-04</p>	<p>PH 系列外六角接头</p> <p>PH series six angle joint</p>  <p>型号 Model: PH4-M5 PH8-M5 PH12-01 PH4-01 PH8-01 PH12-02 PH4-02 PH8-02 PH12-03 PH4-03 PH8-03 PH12-04 PH6-M5 PH8-04 PH14-03 PH6-01 PH10-01 PH14-04 PH6-02 PH10-02 PH16-03 PH6-03 PH10-03 PH16-04 PH6-04 PH10-04</p>	<p>PLF 系列L型内螺纹</p> <p>PLF series L type internal thread</p>  <p>型号 Model: PLF4-M5 PLF8-M5 PLF12-01 PLF4-01 PLF8-01 PLF12-02 PLF4-02 PLF8-02 PLF12-03 PLF4-03 PLF8-03 PLF12-04 PLF6-M5 PLF8-04 PLF14-03 PLF6-01 PLF10-01 PLF14-04 PLF6-02 PLF10-02 PLF16-03 PLF6-03 PLF10-03 PLF16-04 PLF6-04 PLF10-04</p>

执行元件 Actuator Components
磁性开关 Magnetic switch
控制元件 Control Components
空气过滤组合 Air combination
接头系列 Connector Series
接头、气管系列 Connector, hoses series
缓冲器系列 Buffer series
真空元件系列 Vacuum series

PLL 系列弯头加长 PLL series elbow extension  型号 Model PLL4-M5 PLL8-M5 PLL12-01 PLL4-01 PLL8-01 PLL12-02 PLL4-02 PLL8-02 PLL12-03 PLL4-03 PLL8-03 PLL12-04 PLL6-M5 PLL8-04 PLL14-03 PLL6-01 PLL10-01 PLL14-04 PLL6-02 PLL10-02 PLL16-03 PLL6-03 PLL10-03 PLL16-04 PLL6-04 PLL10-04	PKD 系列内螺纹五通 PKD series internal thread five  型号 Model PKD4-M5 PKD8-M5 PKD12-01 PKD4-01 PKD8-01 PKD12-02 PKD4-02 PKD8-02 PKD12-03 PKD4-03 PKD8-03 PKD12-04 PKD6-M5 PKD8-04 PKD14-03 PKD6-01 PKD10-01 PKD14-04 PKD6-02 PKD10-02 PKD16-03 PKD6-03 PKD10-03 PKD16-04 PKD6-04 PKD10-04	PMF 系列穿板内螺纹 PMF series bulkhead female straight  型号 Model PMF4-01 PMF8-04 PMF4-02 PMF10-01 PMF6-01 PMF10-02 PMF6-02 PMF10-03 PMF6-03 PMF10-04 PMF6-04 PMF12-02 PMF8-01 PMF12-03 PMF8-02 PMF12-04 PMF8-03 PMF16-04	SL 系列L型节流 SL series L type throttle  型号 Model SL4-M5 SL8-01 SL12-01 SL4-01 SL8-02 SL12-02 SL4-02 SL8-03 SL12-03 SL4-03 SL8-04 SL12-04 SL6-M5 SL8-M5 SL14-03 SL6-01 SL10-01 SL14-04 SL6-02 SL10-02 SL16-03 SL6-03 SL10-03 SL16-04 SL6-04 SL10-04	PA 系列管道型 PA series pipe type  型号 Model PA-04 PA-06 PA-08 PA-10 PA-12 PA-14 PA-16
HVFF 系列手阀 HVFF series male pipe switch valve  型号 Model HVFF-4 HVFF-6 HVFF-8 HVFF-10 HVFF-12 HVFF-14 HVFF-16	PC-G 系列螺纹直通 PC-G series Threaded Straight  型号 Model PC4-G01 PC8-G03 PC12-G04 PC4-G02 PC8-G04 PC14-G03 PC4-G03 PC10-G01 PC14-G04 PC6-G01 PC10-G02 PC16-G03 PC6-G02 PC10-G03 PC16-G04 PC6-G03 PC10-G04 PC6-G04 PC12-G01 PC8-G01 PC12-G02 PC8-G02 PC12-G03	PL-G 系列L型弯通 PL-G series L-type elbow  型号 Model PL4-G01 PL8-G03 PL12-G04 PL4-G02 PL8-G04 PL14-G03 PL4-G03 PL10-G01 PL14-G04 PL6-G01 PL10-G02 PL16-G03 PL6-G02 PL10-G03 PL16-G04 PL6-G03 PL10-G04 PL6-G04 PL12-G01 PL8-G01 PL12-G02 PL8-G02 PL12-G03	PB-G 系列T型三通 PB-G series T-tee  型号 Model PB4-G01 PB8-G03 PB12-G04 PB4-G02 PB8-G04 PB14-G03 PB4-G03 PB10-G01 PB14-G04 PB6-G01 PB10-G02 PB16-G03 PB6-G02 PB10-G03 PB16-G04 PB6-G03 PB10-G04 PB6-G04 PB12-G01 PB8-G01 PB12-G02 PB8-G02 PB12-G03	PD-G 系列T型侧三通 PD-G series T-type side tee  型号 Model PD4-G01 PD8-G03 PD12-G04 PD4-G02 PD8-G04 PD14-G03 PD4-G03 PD10-G01 PD14-G04 PD6-G01 PD10-G02 PD16-G03 PD6-G02 PD10-G03 PD16-G04 PD6-G03 PD10-G04 PD6-G04 PD12-G01 PD8-G01 PD12-G02 PD8-G02 PD12-G03
PX-G 系列Y型三通 PX-G series Y-tee  型号 Model PX4-G01 PX8-G03 PX12-G04 PX4-G02 PX8-G04 PX14-G03 PX4-G03 PX10-G01 PX14-G04 PX6-G01 PX10-G02 PX16-G03 PX6-G02 PX10-G03 PX16-G04 PX6-G03 PX10-G04 PX6-G04 PX12-G01 PX8-G01 PX12-G02 PX8-G02 PX12-G03	PKD-G 系列五通 PKD-G series Fives Through  型号 Model PKD4-GM5 PKD8-GM5 PKD12-G01 PKD4-G01 PKD8-G01 PKD12-G02 PKD4-G02 PKD8-G02 PKD12-G03 PKD4-G03 PKD8-G03 PKD12-G04 PKD6-G02 PKD10-G03 PKD14-G03 PKD6-G01 PKD10-G01 PKD14-G04 PKD6-G02 PKD10-G02 PKD16-G03 PKD6-G03 PKD10-G03 PKD16-G04 PKD6-G04 PKD10-G04	PC-C 系列微型快速接头 PC-C series micro Express connector  型号 Model PC-C3-M3 PC-C5-02 PC-C3-M5 PC-C6-M5 PC-C3-01 PC-C6-01 PC-C4-M3 PC-C6-02 PC-C4-M5 PC-C4-01 PC-C4-02 PC-C5-M5 PC-C5-01	POC-C 系列微型快速接头 POC-C series micro Express connector  型号 Model POC-C3-M3 POC-C5-02 POC-C3-M5 POC-C6-M5 POC-C3-01 POC-C6-01 POC-C4-M3 POC-C6-02 POC-C4-M5 POC-C4-01 POC-C4-02 POC-C5-M5 POC-C5-01	PL-C 系列微型快速接头 PL-C series compact type  型号 Model PL-C3-M3 PL-C6-M5 PL-C3-M5 PL-C6-01 PL-C3-01 PL-C6-02 PL-C4-M5 PL-C4-01 PL-C4-02 PL-C5-M5 PL-C5-01 PL-C5-02

PC	8	02
系列号	气分管径	螺纹型式
	4	01:1/8"
	6	02:1/4"
	8	03:3/8"
	10	04:1/2"
	12	
	14	
	16	

安全警告
请勿使用空气和水以外的任何流体(某些型号可以用水)
在有火花的使用场合,请选用全金属接头,以免引起火灾
在需要旋转的场合使用,请使用旋转型接头
在60°以上的高温环境中(水或热油)使用,请与本公司联系后再使用
在需要防静电的环境下使用,请与本公司联系后再使用,静电可能导致产品质量下降或引起故障
在接头上施加外部负荷(扭曲、弯曲、牵拉)有可能导致产品损坏或泄露

单边接头:KQ2C Unilateral fitting:KQ2C  型号 Model KQ2C-04 KQ2C-06 KQ2C-08 KQ2C-10 KQ2C-12	外螺正三通接头:KQ2D Positive external screw tee:KQ2D  型号 Model KQ2D04-M5 KQ2D06-03S KQ2D12-02S KQ2D04-M6 KQ2D08-01S KQ2D12-03S KQ2D04-01S KQ2D08-02S KQ2D12-04S KQ2D04-02S KQ2D08-03S KQ2D06-M5 KQ2D10-01S KQ2D06-M6 KQ2D10-02S KQ2D06-01S KQ2D10-03S KQ2D06-02S KQ2D10-04S	正三通接头:KQ2D Positive tee:KQ2D  型号 Model KQ2D04-00 KQ2D06-00 KQ2D08-00 KQ2D10-00 KQ2D12-00	隔板接头:KQ2E Bulkhead connector:KQ2E  型号 Model KQ2E04-00 KQ2E06-00 KQ2E08-00 KQ2E10-00 KQ2E12-00 KQ2E16-00	内螺隔板接头:KQ2E Lo bulkhead connector:KQ2E  型号 Model KQ2E04-M5 KQ2E08-03S KQ2E16-04 KQ2E04-01 KQ2E10-02 KQ2E04-02 KQ2E10-03 KQ2E06-01 KQ2E10-04 KQ2E06-02 KQ2E12-03 KQ2E06-03 KQ2E12-04 KQ2E08-01 KQ2E16-02 KQ2E08-02 KQ2E16-03
隔板弯接头:KQ2LE Bulkhead elbow connector:KQ2LE  型号 Model KQ2LE04-00 KQ2LE06-00 KQ2LE08-00 KQ2LE10-00 KQ2LE12-00	内螺直接头:KQ2F Lo direct head:KQ2F  型号 Model KQ2F04-M5 KQ2F08-02 KQ2F12-04 KQ2F04-01 KQ2F08-03 KQ2F16-03 KQ2F04-02 KQ2F10-01 KQ2F16-04 KQ2F06-M5 KQ2F10-02 KQ2F06-01 KQ2F10-03 KQ2F06-02 KQ2F10-04 KQ2F06-03 KQ2F12-02 KQ2F08-01 KQ2F12-03 KQ2F08-02S KQ2F10-04S	外螺直接头:KQ2H Foreign direct screw head:KQ2H  型号 Model KQ2H04-M5 KQ2H06-03S KQ2H12-02S KQ2H04-M6 KQ2H08-01S KQ2H12-03S KQ2H04-01S KQ2H08-02S KQ2H12-04S KQ2H04-02S KQ2H08-03S KQ2H16-03S KQ2H06-M5 KQ2H10-01S KQ2H16-04S KQ2H06-M6 KQ2H10-02S KQ2H06-01S KQ2H10-03S KQ2H06-02S KQ2H10-04S	等径直接头:KQ2H Such as straight joints:KQ2H  型号 Model KQ2H04-00 KQ2H04-06 KQ2H06-00 KQ2H04-08 KQ2H08-00 KQ2H06-08 KQ2H10-00 KQ2H06-10 KQ2H12-00 KQ2H08-10 KQ2H16-00 KQ2H08-12 KQ2H10-12 KQ2H12-16	外螺弯接头:KQ2L Outer spiral bending joints:KQ2L  型号 Model KQ2L04-M5 KQ2L06-03S KQ2L12-02S KQ2L04-M6 KQ2L08-01S KQ2L12-03S KQ2L04-01S KQ2L08-02S KQ2L12-04S KQ2L04-02S KQ2L08-03S KQ2L16-03S KQ2L06-M5 KQ2L10-01S KQ2L16-04S KQ2L06-M6 KQ2L10-02S KQ2L06-01S KQ2L10-03S KQ2L06-02S KQ2L10-04S
等径弯接头:KQ2L Equal elbow connector:KQ2L  型号 Model KQ2L04-00 KQ2L06-00 KQ2L08-00 KQ2L10-00 KQ2L12-00 KQ2L16-00	外螺加长弯接头:KQ2W Long curved outer screw joints:KQ2W  型号 Model KQ2W04-M5 KQ2W06-03S KQ2W12-02S KQ2W04-M6 KQ2W08-01S KQ2W12-03S KQ2W04-01S KQ2W08-02S KQ2W12-04S KQ2W04-02S KQ2W08-03S KQ2W16-03S KQ2W06-M5 KQ2W10-01S KQ2W16-04S KQ2W06-M6 KQ2W10-02S KQ2W06-01S KQ2W10-03S KQ2W06-02S KQ2W10-04S	变径弯插接头:KBQ2L Adjustable curved plug connector:KQ2L  型号 Model KQ2L04-06 KQ2L04-99 KQ2L04-08 KQ2L06-99 KQ2L06-08 KQ2L08-99 KQ2L06-10 KQ2L10-99 KQ2L08-10 KQ2L12-99 KQ2L08-12 KQ2L10-12 KQ2L12-16	等径加长弯插接头:KQ2W Equal extended curved plug connector:KQ2W  型号 Model KQ2W04-99 KQ2W08-99 KQ2W10-99 KQ2W12-99	内螺弯接头:KQ2LF Lo bending joints:KQ2LF  型号 Model KQ2LF04-M5 KQ2LF08-02 KQ2LF12-04 KQ2LF04-01 KQ2LF08-03 KQ2LF16-03 KQ2LF04-02 KQ2LF10-01 KQ2LF16-04 KQ2LF06-M5 KQ2LF10-02 KQ2LF06-01 KQ2LF10-03 KQ2LF06-02 KQ2LF10-04 KQ2LF06-03 KQ2LF12-02 KQ2LF08-01 KQ2LF12-03
外螺偏三通接头:KQ2LU Outer screw partial tee:KQ2LU  型号 Model KQ2LU04-M5 KQ2LU06-03S KQ2LU12-02S KQ2LU04-M6 KQ2LU08-01S KQ2LU12-03S KQ2LU04-01S KQ2LU08-02S KQ2LU12-04S KQ2LU04-02S KQ2LU08-03S KQ2LU06-M5 KQ2LU10-01S KQ2LU06-M6 KQ2LU10-02S KQ2LU06-01S KQ2LU10-03S KQ2LU06-02S KQ2LU10-04S	偏三通接头:KQ2LU Bias tee: KQ2LU  型号 Model KQ2LU04-00 KQ2LU06-00 KQ2LU08-00 KQ2LU10-00 KQ2LU12-00	内六角接头:KQ2S Hexagon fitting:KQ2S  型号 Model KQ2S04-M5 KQ2S08-01S KQ2S12-03S KQ2S04-M6 KQ2S08-02S KQ2S12-04S KQ2S04-01S KQ2S08-03S KQ2S16-03S KQ2S04-02S KQ2S10-01S KQ2S16-04S KQ2S06-M5 KQ2S10-02S KQ2S06-M6 KQ2S10-03S KQ2S06-01S KQ2S10-04S KQ2S06-02S KQ2S12-02S	外螺T型接头:KQ2T Outer screw T-connector:KQ2T  型号 Model KQ2T04-M5 KQ2T06-03S KQ2T12-02S KQ2T04-M6 KQ2T08-01S KQ2T12-03S KQ2T04-01S KQ2T08-02S KQ2T12-04S KQ2T04-02S KQ2T08-03S KQ2T16-03S KQ2T06-M5 KQ2T10-01S KQ2T16-04S KQ2T06-M6 KQ2T10-02S KQ2T06-01S KQ2T10-03S KQ2T06-02S KQ2T10-04S	T型三通接头:KQ2T T-tee:KQ2T  型号 Model KQ2T04-00 KQ2T06-04 KQ2T04-06 KQ2T06-00 KQ2T08-06 KQ2T06-08 KQ2T08-00 KQ2T10-08 KQ2T08-10 KQ2T10-00 KQ2T12-10 KQ2T10-12 KQ2T12-00 KQ2T16-12 KQ2T16-00

执行元件
磁性开关
控制元件
气路过滤组合
接头系列
接头、气管系列
缓冲器系列
真空元件系列

<p>调速阀/用螺丝刀调节:AS**01F-D Control valve/regulator with screw driver AS**01F-D</p>  <p>型号 Model AS2201F-01-04S-D AS2201F-03-06S-D AS2201F-01-06S-D AS2201F-03-08S-D AS2201F-01-08S-D AS2201F-03-10S-D AS2201F-01-10S-D AS2201F-03-12S-D AS2201F-02-04S-D AS2201F-04-10S-D AS2201F-02-06S-D AS2201F-04-12S-D AS2201F-02-08S-D AS2201F-02-10S-D</p>	<p>速度控制阀带消音器:AQ Speed control valve with muffler:AQ</p>  <p>型号 Model AQ240F-04-00 AQ240F-06-00 AQ340F-06-00 AQ240F-04-04 AQ240F-06-06 AQ340F-06-06</p>	<p>速度控制阀带消音器:ASN2 Speed control valve:ASN2</p>  <p>型号 Model ASN2-M5 ASN2-01 ASN2-02 ASN2-03 ASN2-04</p>	<p>外螺T型接头:KQ2T Outer screw T-connector:KQ2T</p>  <p>型号 Model KQ2T04-U01 KQ2T08-U04 KQ2T12-U04 KQ2T04-U02 KQ2T10-U01 KQ2T16-U03 KQ2T06-U01 KQ2T10-U02 KQ2T16-U04 KQ2T06-U02 KQ2T10-U03 KQ2T06-U03 KQ2T10-U04 KQ2T08-U01 KQ2T12-U01 KQ2T08-U02 KQ2T12-U02 KQ2T08-U03 KQ2T12-U03</p>	<p>外螺U型接头:KQ2U Outer spiral U-joint:KQ2U</p>  <p>型号 Model KQ2U04-U01 KQ2U08-U04 KQ2U12-U04 KQ2U04-U02 KQ2U10-U01 KQ2U16-U03 KQ2U06-U01 KQ2U10-U02 KQ2U16-U04 KQ2U06-U02 KQ2U10-U03 KQ2U06-U03 KQ2U10-U04 KQ2U08-U01 KQ2U12-U01 KQ2U08-U02 KQ2U12-U02 KQ2U08-U03 KQ2U12-U03</p>
<p>外螺Y型接头:KQ2Y Y-connector external thread:KQ2Y</p>  <p>型号 Model KQ2Y04-U01 KQ2Y08-U04 KQ2Y12-U04 KQ2Y04-U02 KQ2Y10-U01 KQ2Y16-U03 KQ2Y06-U01 KQ2Y10-U02 KQ2Y16-U04 KQ2Y06-U02 KQ2Y10-U03 KQ2Y06-U03 KQ2Y10-U04 KQ2Y08-U01 KQ2Y12-U01 KQ2Y08-U02 KQ2Y12-U02 KQ2Y08-U03 KQ2Y12-U03</p>	<p>调速阀:AS Control Valve:AS</p>  <p>型号 Model AS2201F-U01-04 AS2201F-01S-10 AS2201F-U02-04 AS2201F-U02-10 AS2201F-U01-06 AS2201F-U03-10 AS2201F-U02-06 AS2201F-U04-10 AS2201F-U03-06 AS2201F-U03-12 AS2201F-01S-08 AS2201F-U04-12 AS2201F-U02-08 AS2201F-U03-08</p>	<p>外螺直接头:KQ2H Foreign direct screw head:KQ2H</p>  <p>型号 Model KQ2H04-U01 KQ2H08-U04 KQ2H12-U04 KQ2H04-U02 KQ2H10-U01 KQ2H16-U03 KQ2H06-U01 KQ2H10-U02 KQ2H16-U04 KQ2H06-U02 KQ2H10-U03 KQ2H06-U03 KQ2H10-U04 KQ2H08-U01 KQ2H12-U01 KQ2H08-U02 KQ2H12-U02 KQ2H08-U03 KQ2H12-U03</p>	<p>内六角接头:KQ2S Hexagon fitting:KQ2S</p>  <p>型号 Model KQ2S04-U01 KQ2S08-U04 KQ2S12-U04 KQ2S04-U02 KQ2S10-U01 KQ2S16-U03 KQ2S06-U01 KQ2S10-U02 KQ2S16-U04 KQ2S06-U02 KQ2S10-U03 KQ2S06-U03 KQ2S10-U04 KQ2S08-U01 KQ2S12-U01 KQ2S08-U02 KQ2S12-U02 KQ2S08-U03 KQ2S12-U03</p>	<p>外螺弯接头:KQ2L Outer spiral bending joints:KQ2L</p>  <p>型号 Model KQ2L04-U01 KQ2L08-U04 KQ2L12-U04 KQ2L04-U02 KQ2L10-U01 KQ2L16-U03 KQ2L06-U01 KQ2L10-U02 KQ2L16-U04 KQ2L06-U02 KQ2L10-U03 KQ2L06-U03 KQ2L10-U04 KQ2L08-U01 KQ2L12-U01 KQ2L08-U02 KQ2L12-U02 KQ2L08-U03 KQ2L12-U03</p>
<p>直通旋转接头:KSH Straight rotary joint:KSH</p>  <p>型号 Model KSH04-M5 KSH08-02S KSH04-M6 KSH08-03S KSH04-01S KSH10-02S KSH06-M5 KSH10-03S KSH06-M6 KSH10-04S KSH06-01S KSH12-03S KSH06-02S KSH12-04S KSH08-01S</p>	<p>弯通旋转接头:KSL Elbow swivel Joint:KSL</p>  <p>型号 Model KSL04-M5 KSL08-02S KSL04-M6 KSL08-03S KSL04-01S KSL10-02S KSL06-M5 KSL10-03S KSL06-M6 KSL10-04S KSL06-01S KSL12-03S KSL06-02S KSL12-04S KSL08-01S</p>	<p>单向阀:AKH Check valve:AKH</p>  <p>型号 Model AKH04-00 AKH06-00 AKH08-00 AKH10-00 AKH12-00</p>	<p>单向阀:AKH Check valve:AKH</p>  <p>型号 Model AKH04A-M5 AKH10A-02S AKH04A-01S AKH10A-03S AKH06A-M5 AKH10A-04S AKH06A-01S AKH12A-03S AKH06A-02S AKH12A-04S AKH08A-01S AKH08A-02S AKH08A-03S</p>	<p>单向阀:AKH Check valve:AKH</p>  <p>型号 Model AKH04B-M5 AKH10B-02S AKH04B-01S AKH10B-03S AKH06B-M5 AKH10B-04S AKH06B-01S AKH12B-03S AKH06B-02S AKH12B-04S AKH08B-01S AKH08B-02S AKH08B-03S</p>
<p>单向阀:AKB Check valve:AKB</p>  <p>型号 Model AKB01A-01S AKB01B-01S AKB02A-02S AKB02B-02S AKB03A-03S AKB03B-03S AKB04A-04S AKB04B-04S</p>	<p>直通接头:KCH Through connector:KCH</p>  <p>型号 Model KCH04-M5 KCH10-02S KCH04-01S KCH10-03S KCH06-M5 KCH12-03S KCH06-01S KCH12-04S KCH06-02S KCH08-01S KCH08-02S KCH08-03S</p>	<p>弯接头:KCL Bending Joints:KCL</p>  <p>型号 Model KCL04-M5 KCL10-02S KCL04-01S KCL10-03S KCL06-M5 KCL12-03S KCL06-01S KCL12-04S KCL06-02S KCL08-01S KCL08-02S KCL08-03S</p>	<p>等径直通接头:KCH Such as straight through joints:KCH</p>  <p>型号 Model KCH04-00 KCH06-00 KCH08-00 KCH10-00 KCH12-00</p>	<p>手动阀:VHK Manual valve:VHK</p>  <p>型号 Model VHK□-04F-04F VHK□-12F-12F VHK□-06F-04F VHK□-06F-06F VHK□-08F-06F VHK□-08F-08F VHK□-10F-08F VHK□-10F-10F VHK□-12F-10F</p>

<p>手动阀:VHK Manual valve:VHK</p>  <p>型号 Model VHK□-M5-04F VHK□-02S-12F VHK□-M5-06F VHK□-03S-06F VHK□-01S-04F VHK□-03S-08F VHK□-01S-06F VHK□-03S-10F VHK□-01S-08F VHK□-03S-12F VHK□-02S-06F VHK□-04S-10F VHK□-02S-08F VHK□-04S-12F VHK□-02S-10F</p>	<p>手动阀:VHK Manual valve:VHK</p>  <p>型号 Model VHK□-04F-M5 VHK□-08F-03S VHK□-04F-01S VHK□-10F-02S VHK□-06F-M5 VHK□-10F-03S VHK□-06F-01S VHK□-10F-04S VHK□-06F-02S VHK□-12F-02S VHK□-06F-03S VHK□-12F-03S VHK□-08F-01S VHK□-12F-04S VHK□-08F-02S</p>	<p>手动阀:VHK Manual valve:VHK</p>  <p>型号 Model VHK□-M5-M5 VHK□-04S-04S VHK□-01S-M5 VHK□-01S-01S VHK□-02S-01S VHK□-02S-02S VHK□-03S-02S VHK□-03S-03S</p>	<p>真空发生器:ZH Vacuum Generators:ZH</p>  <p>型号 Model ZH05BS-06-06 ZH05BL-06-06 ZH07BS-06-06 ZH07BL-06-06 ZH10BS-06-06 ZH10BL-06-06 ZH13BS-08-10 ZH13BL-08-10</p>	<p>真空发生器:ZH Vacuum Generators:ZH</p>  <p>型号 Model ZH05BS-01-01 ZH05BL-01-01 ZH07BS-01-01 ZH07BL-01-01 ZH10BS-01-01 ZH10BL-01-01 ZH13BS-01-02 ZH13BL-01-02</p>
<p>真空发生器:ZH Vacuum Generators:ZH</p>  <p>型号 Model ZH05DS-06-06-06 ZH05DL-06-06-06 ZH07DS-06-06-06 ZH07DL-06-06-06 ZH10DS-06-06-08 ZH10DL-06-06-08 ZH13DS-08-10-10 ZH13DL-08-10-10 ZH15DS-10-12-12 ZH15DL-10-12-12 ZH18DS-12-12-12 ZH18DL-12-12-12 ZH20DS-12-16-16 ZH20DL-12-16-16</p>	<p>真空发生器:ZH Vacuum Generators:ZH</p>  <p>型号 Model ZH05DS-01-01-01 ZH05DL-01-01-01 ZH07DS-01-01-01 ZH07DL-01-01-01 ZH10DS-01-01-01 ZH10DL-01-01-01 ZH13DS-01-02-02 ZH13DL-01-02-02 ZH15DS-02-03-03 ZH15DL-02-03-03 ZH18DS-03-03-03 ZH18DL-03-03-03 ZH20DS-03-04-04 ZH20DL-03-04-04</p>	<p>直管型真空发生器:ZU Straight thbetype vacuum generator:ZU</p>  <p>型号 Model ZU05S ZU07S ZU05L ZU07L</p>	<p>微型管接头:M Micro fittings:M</p>  <p>型号 Model 4-M5 5-M5 6-M5</p>	<p>微型管接头:M Micro fittings:M</p>  <p>型号 Model 4-M5 5-M5 6-M5</p>
<p>消声器 Muffler</p>  <p>型号 Model AN200-02 AN300-03 AN400-04</p>	<p>消声器 Muffler</p>  <p>型号 Model AN101-02 AN201-03 AN301-03 AN401-04</p>	<p>消声器 Muffler</p>  <p>型号 Model M5" 1/8" 1/4" 3/8" 1/2" 3/4" 1"</p>	<p>剪管器 Shear Hose</p>  <p>型号 Model JGQ</p>	

PU系列气管 PU Series tube

订货型号

PU 0425 B 1000



气管大小(mm) Pipe Size(mm)		
型号	外径	内径
0302	Φ3	Φ2
0425	Φ4	Φ2.5
0604	Φ6	Φ4
0805	Φ8	Φ5
1065	Φ10	Φ6.5
1208	Φ12	Φ8
1410	Φ14	Φ10
1612	Φ16	Φ12

颜色 Colour	
B	黑
W	白
R	红
U	蓝
Y	黄
G	绿
C	透明
CU	透明蓝
CG	透明绿

每卷可选长度 Optional length per roll	
500	500米
100	1000米

执行元件
磁性开关
控制元件
空气过滤组合
接头系列
接头、气管系列
缓冲器系列
真空元件系列

AC系列油压缓冲器 AC Series shock absorbers

产品图片 Product picture	AC	14	16	-	1	N
	<p>系列号 Series vale AC:自动补偿式 AC:auto-compesate</p>	<p>轴套外牙 Por size 08 10 10 12 14 14 20 20 25 25 36</p>	<p>冲击行程 Stroke 06 05 08 10 12 16 20 25 40 60</p>		<p>冲击速度 Shock speed 1.高速 2.中速 3.低速 1:high 2:midst 3:low</p>	<p>缓冲帽 Absorber cap 空白:带缓冲帽 N:不带缓冲帽 Blank:with buffer cap N:not with buffer cap</p>

ACD系列油压缓冲器 ACD Series shock absorbers

产品图片 Product picture	ACD	14	16	-	1	N
	<p>系列号 Series vale ACD:双向缓冲式 ACD:bidirectional buffer</p>	<p>轴套外牙 Por size 20 20 20 20</p>	<p>冲击行程 Stroke 30 30 35 35</p>		<p>冲击速度 Shock speed 1.高速 2.中速 3.低速 1:high 2:midst 3:low</p>	<p>缓冲帽 Absorber cap 空白:带缓冲帽 N:不带缓冲帽 Blank:with buffer cap N:not with buffer cap</p>

AD系列油压缓冲器 AD Series shock absorbers

产品图片 Product picture	AD	14	16	-	1	N
	<p>系列号 Series vale AD:可调式 AD:adjustable</p>	<p>轴套外牙 Por size 14 20 25 25 36 42 42 42 64 64 64</p>	<p>冲击行程 Stroke 10 16 25 40 50 25 50 75 50 100 150</p>		<p>冲击速度 Shock speed 1.高速 2.中速 3.低速 1:high 2:midst 3:low</p>	<p>缓冲帽 Absorber cap 空白:带缓冲帽 N:不带缓冲帽 Blank:with buffer cap Nnot with buffer cap</p>

SR系列精密稳速器 SR Series Precision steady speed

产品图片 Product picture	SR	30
	<p>系列号 Series vale SR:精密稳速器 SR:Precision steady speed</p>	<p>行程 Stroke 15:15mm 30:30mm 60:60mm</p>

RB系列液压缓冲器 RB Series shock absorbers

产品图片 Product picture	RB	C	14	12	□
	<p>系列号 Series vale RB:基本型 RB:Basic</p>	<p>空白:基本型 C:带胶垫型 N:basic type C:with rubber cushion</p>	<p>外径螺纹 OD Thread 08 10 20 27</p>	<p>吸收行程 Absorption stroke 06 07 15 25</p>	<p>可选项 Options 无记号:无 S:带限位螺母 J:追加六角螺母1个(*计3个) N:带六角螺母2个是标准件 S:with the stop nut J:Append hex nut 1(*count3) *Installed with a hex nut 2 is the standard</p>

ZP系列 ZP Series 标准型吸盘	ZPT系列 ZPT Series 不带缓冲垂直真空接管吸盘	ZPT系列 ZPT Series 带缓冲垂直真空接管吸盘	ZPR系列 ZPR Series 不带缓冲水平真空接管吸盘
			
ZPR系列 ZPR Series 带缓冲水平真空接管吸盘	SAN系列 SAN Series 喷嘴式吸盘	SAO系列 SAO Series 椭圆扁平吸盘	SAOT系列 SAOT Series 椭圆扁平吸盘
			
SAOT系列 SAOT Series 带缓冲垂直真空接管吸盘	SAOR系列 SAOR Series 不带缓冲水平真空接管吸盘	SAOR系列 SAOR Series 带缓冲水平真空接管吸盘	PAG系列 PAG Series 薄型吸盘
			
PATK/PAYK系列 PATK/PAYK Series 薄型吸盘固定式金属底座	PATS系列 PATS Series 平面薄型立向缓冲吸盘组	PAYS系列 PAYS Series 平面薄型横向缓冲吸盘组	PATKM/PAYKM系列 PATKM/PAYKM Series 带缓冲式金属底座及快速接管型薄型吸盘
			

执行元件 Actuator Components
磁性开关 Magnetic switch
控制元件 Control Components
空气过滤组合 Air combination
接头系列 Connector Series
接头、气管系列 Connector, Indica Series
缓冲器系列 Buffer Series
真空元件系列 Vacuum Series

PCG系列 PCG Series 三段式吸盘	PCTK/PCYK系列 PCTK/PCYK Series 三段式吸盘附接头固定式金属配件	PFG系列 PFG Series 标准型吸盘	PFTKM/PFYKM系列 PFTKM/PFYKM Series 快速接管型标准吸盘固定金属底座
PFTK/PFYK系列 PFTK/PFYK Series 标准型吸盘固定金属底座	PFTS系列 PFTS Series 标准立向缓冲吸盘组	PFYS系列 PFYS Series 标准横向缓冲吸盘组	PJG系列 PJG Series 双层吸盘
PJTK/PJYK系列 PJTK/PJYK Series 双层吸盘/固定金属底座	PJTS系列 PJTS Series 双层立向缓冲吸盘组	PJYS系列 PJYS Series 双层横向缓冲吸盘组	PJG系列 PJG Series 无痕吸盘
PS系列 PS Series 吸盘附接头	PUG系列 PUG Series 摇摆型吸盘	PUTKB/PUYKB系列 PUTKB/PUYKB Series 摇摆型吸盘附固定式金属底座	PUTSB/PUYSB系列 PUTSB/PUYSB Series 摇摆型吸盘/附弹簧缓冲底座

SH系列 SH Series 大型吸盘	SH系列 SH Series 带缓冲大型吸盘	SH系列 SH Series 不带缓冲大型吸盘	SHB系列 SHB Series 大型风琴形吸盘
SHB系列 SH Series 带缓冲大型风琴形吸盘	SHB系列 SHB Series 不带缓冲大型风琴形吸盘	SNT系列 SNT Series 无接触式吸盘	PK2系列 PK2 Series 扁平型高耐久性油性钣金吸盘
PK2B系列 PK2B Series 波纹型高耐久性油性钣金吸盘	PK2L系列 PK2L Series 椭圆型高耐久性油性钣金吸盘	PL系列 PL Series 多段褶皱吸盘	T26系列 T26 Series 平行带肋吸盘
T33系列 T33 Series 平行带肋吸盘	SB系列 SB Series 通用型波纹吸盘	SBLP系列 SBLP Series 软包装袋专用多折波纹吸盘	

执行元件
Actuator Components

磁性开关
Magnetic switch

控制元件
Control Components

空气过滤组合
Air combination

接头系列
Connector Series

接头、气管系列
Connector, hoses series

缓冲器系列
Buffer series

真空元件系列
Vacuum series